

# Flexitouch® Plus User Guide

Model PD32-G3



## FLEXITOUCH® PLUS

ADVANCED PNEUMATIC COMPRESSION SYSTEM

**Tactile**  
MEDICAL®

# Table of Contents

Determine which garment style you have and follow directions for that garment: Flexitouch Plus with ComfortEase or Flexitouch Plus.

**NOTE: Flexitouch Plus with ComfortEase directions are found on the gray pages within this User Guide.**

<b>Chapter 1 Before You Get Started</b> .....	<b>1</b>
1.1 How to Contact Tactile Medical .....	1
1.2 Safety Precautions and Explanation of Symbols.....	2
1.3 Indications for Use .....	4
1.4 Contraindications .....	5
1.5 Unpacking Instructions .....	6
1.6 Kylee – Personal Lymphedema Assistant Mobile Application ...	8
<b>Chapter 2 The Flexitouch Plus System</b> .....	<b>11</b>
2.1 System Components .....	11
2.2 Programmed Pressure Levels .....	12
2.3 Treating the Lower Extremity .....	15
2.4 Treating the Upper Extremity .....	19
2.5 Treating the Head and Neck .....	24
<b>Chapter 3 Controller Unit Setup</b> .....	<b>26</b>
3.1 Setting Up Your Controller Unit .....	26
3.2 Selecting Your Settings .....	27
<b>Chapter 4 Connecting Your Hoses to the Controller Unit</b> .....	<b>30</b>
4.1 Connecting Your Bilateral Port Adapter.....	30
4.2 Connecting Your Flexitouch Plus Lock/Unlock Style Connectors to the Controller Unit.....	32
4.3 Connecting Your Flexitouch Plus Hoses to the Controller Unit – Ridged Style .....	36
<b>Chapter 5 Trunk Garment Application</b> .....	<b>39</b>
5.1 Applying Your Flexitouch Plus with ComfortEase Trunk Garment .....	40
5.2 Applying Your Flexitouch Plus Trunk Garment .....	43
<b>Chapter 6 Lower Extremity Garment Application</b> .....	<b>45</b>
6.1 Applying Your Flexitouch Plus with ComfortEase Full Leg Garment.....	46
6.2 Applying Your Flexitouch Plus Full Leg Garment.....	50

6.3 Applying Your Flexitouch Plus Half Leg Garment.....	53
6.4 Applying Your Flexitouch Plus EXT Half Leg Garment and Trunk-Thigh Garment.....	55

## **Chapter 7 Upper Extremity Garment Application** ....58

7.1 Applying Your Flexitouch Plus with ComfortEase Vest Garment .....	59
7.2 Applying Your Flexitouch Plus with ComfortEase Vest and Arm Garment .....	66
7.3 Applying Your Flexitouch Plus Arm-Shoulder Garment.....	83

## **Chapter 8 Head and Neck Garment Application** .....89

8.1 Applying Your Flexitouch Plus with ComfortEase Vest Garment .....	90
8.2 Applying Your Flexitouch Plus with ComfortEase Head Garment .....	97
8.3 Applying Your Flexitouch Plus Vest Garment .....	105
8.4 Applying Your Flexitouch Plus Head Garment .....	108

## **Chapter 9 Conducting Your Treatment Session** .....113

9.1 Starting Your Treatment Session .....	113
9.2 Pausing Your Treatment Session .....	114
9.3 Completing Your Treatment Session .....	114
9.4 Turning Your Controller Unit Off.....	114
9.5 Storing Your Flexitouch Plus System.....	114
9.6 Cleaning Your Flexitouch Plus System .....	115

## **Chapter 10 Troubleshooting and Specifications** .....117

10.1 Troubleshooting .....	117
10.2 Limited Warranty and Service for Home Use.....	122
10.3 Limited Warranty and Service for Facility Use .....	123
10.4 Equipment Lifetime .....	123
10.5 Return Policy.....	123
10.6 Patents .....	123
10.7 Technical Information .....	124
10.8 Device Label .....	128

## **Appendix A** .....

A Clinician-Directed Manual Pressure Adjustment .....	130
---	-----

## **For Additional Questions**..... 133

# Before You Get Started

Read the entire User Guide before attempting to connect or operate this product.

The Flexitouch Plus system is designed for at-home treatment of lymphedema, chronic edema and chronic wounds. When used daily, the Flexitouch Plus system can help you manage your condition, improve your health and allow you to enjoy a better quality of life.

This User Guide provides the information needed to set up and use your Flexitouch Plus system.

Determine which garment style you have and follow directions for that garment:

## Lower Extremity

- Flexitouch Plus with ComfortEase (Figure 1.a).
- Flexitouch Plus (Figure 1.b).

## Upper Extremity

- Flexitouch Plus with ComfortEase (Figure 1.c).
- Flexitouch Plus (Figure 1.d).

**NOTE: Flexitouch Plus with ComfortEase directions are found on the gray pages within this User Guide.**

## 1.1 How to Contact Tactile Medical

If you have questions about the Flexitouch Plus system or require service, contact Tactile Medical:

- Text or Call:** 612.355.5100

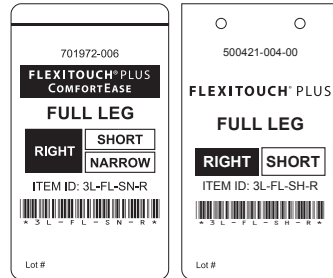


Figure 1.a.

Figure 1.b.

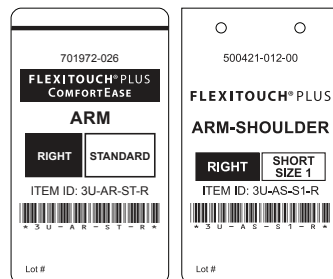


Figure 1.c.

Figure 1.d.

- Toll Free Phone:** 833.3TACTILE (833.382.2845)
- Email:** customerservice@tactilemedical.com
- Customer Care Hours:** 7 a.m. to 7 p.m. CT, Monday–Friday

If you have medical questions, please contact your physician or healthcare provider.

## 1.2 Safety Precautions and Explanation of Symbols

	<p><b>IMPORTANT: Read Instructions Before Using</b> Before attempting to connect or operate this product, please read the entire User Guide. Keep this User Guide available for future reference.</p>
	<p><b>CAUTION</b></p>
	<p><b>MANUFACTURER'S PART NUMBER</b></p>
<p><b>Rx Only</b></p>	<p> <b>CAUTION:</b> U.S. Federal law restricts this device to sale by or on the order of a licensed healthcare professional. The device may only be used by individuals for whom it has been prescribed. Consult your physician or other healthcare provider for recommendations regarding your treatment program, treatment cycles and/or duration of treatment. Use this product only at the settings prescribed by your healthcare provider.</p>
	<p><b>Do NOT Dispose with General Household Waste</b> Tactile Medical complies with the Waste Electric and Electronic Equipment Directive (WEEE) 2002/96/EC. Contact Tactile Medical at 612.355.5100 or toll free at 833.3TACTILE (833.382.2845), 7 a.m. to 7 p.m. CT, Monday–Friday to get disposal instructions.</p>
	<p><b>Type BF Applied Part</b></p>
	<p><b>Device Serial Number</b></p>
	<p><b>Intertek ETL Mark</b> Product Category: Medical Equipment Product Category CCN: PIDF Class II with respect to electrical shock, fire and mechanical hazards only in accordance with EN60601-1</p>
<p><b>IP21</b> Flexitouch Plus system complies with IEC60329 regarding degree of protection against water and particulates.</p>	

**WARNING: Risk of Electric Shock**

- Do not attempt to service the controller unit. Such attempts could result in injury or damage to the product and will void any warranty.
- Do not disassemble the controller unit.
- Only use the power adapter provided with your Flexitouch Plus system.
- Unplug the controller unit when not in use.
- The Flexitouch Plus system is to be used indoors only.
- Do not use the controller unit near water or while bathing.
- Do not reach for the controller unit if it falls into water. Unplug the controller unit at the electrical outlet immediately.
- Do not use the controller unit or garments if they become wet. Dry them off before use or wait until they become dry.

**EMC Precautions**

The Flexitouch Plus system is Medical Electrical Equipment that has been tested and demonstrated to be compatible with electromagnetic compatibility (EMC) CISPR 11 Class B limits and is therefore suitable for use in hospital, clinic and home care environments.

**WARNING:** Although the Flexitouch Plus system has no essential performance affected by EMC, use of this equipment adjacent to or stacked with other equipment should be avoided, because it could result in improper operation. If such use is necessary, this equipment and the other equipment should be observed to verify that they are operating normally.

**WARNING:** Power cords can be affected by EMC. Use only the power cord provided by Tactile Medical.

**WARNING:** Portable RF communications equipment (including peripherals, such as antenna cables and external antennas) should be used no closer than 30 cm (12 inches) to any part of the Flexitouch Plus system.

**WARNING: Risk of Personal Injury**

- Use the controller unit only for its intended purpose, as directed in this User Guide.
- Use accessories only if recommended or supplied by Tactile Medical.
- Set up the controller unit in a manner that provides easy access to the power cord should it become necessary to unplug quickly.
- Never operate the controller unit if the cord or plug is not working properly, if it has been damaged or if the controller unit has been dropped into water. Return it to Tactile Medical for inspection and/or replacement. Do not modify the cord or plug.
- Keep the power cord away from heated surfaces.
- Never operate the controller unit where the cord or tubing harness will present a strangulation or tripping hazard.
- Strangulation potential: power cord and tubing bundle should never be placed near or around a person's neck.
- Never smoke while wearing product garments or while operating the product.

**! CAUTION: Risk of Device Damage**

- Never block the ventilation openings on the sides of the controller unit. Keep the ventilation openings free of debris, such as lint and hair.
- Never operate the controller unit on a soft surface, such as a bed, couch or pillow, where the ventilation openings may be blocked.
- Never drop or insert any object into any opening of the controller unit.
- Never use sharp objects, such as pins, scissors or clasps, on or near the Flexitouch Plus system.
- Never use hot devices, such as irons or blow dryers, on or near the Flexitouch Plus system.
- Keep the product free from debris to avoid valve-closed or valve-opened failures.
- Never place the product in a position or location that would allow the tubing harness to become pinched or crushed.

**! PRECAUTION**

Theoretically, massage and mechanical compression could mobilize dormant tumor cells in some patients; however, this is expected to have limited impact on prognosis, such that the benefits of reduction in morbid edema will likely outweigh those theoretical risks.

**1.3 Indications for Use**

The Flexitouch Plus system and garments for legs, arms, trunk and chest are intended for use by medical professionals and patients who are under medical supervision to increase lymphatic flow in the treatment of many conditions, such as:

- Lymphedema
- Primary lymphedema
- Post-mastectomy edema
- Edema following trauma and sports injuries
- Post-immobilization edema
- Venous insufficiency
- Reduction in wound healing time
- Treatment and assistance in healing stasis dermatitis, venous stasis ulcers, and arterial and diabetic leg ulcers
- Lipedema
- Phlebolympheidema

The Flexitouch Plus system and garments for the head and neck are intended for use by medical professionals and patients who are under medical supervision for the treatment of head and neck lymphedema.



## 1.4 Contraindications

**The Flexitouch Plus system should not be used if you have one or more of the following conditions:**

- Heart failure (acute pulmonary edema, decompensated acute heart failure)
- Acute venous disease (acute thrombophlebitis, acute deep venous thrombosis, acute pulmonary embolism)
- Severe peripheral artery disease (critical limb ischemia, including ischemic rest pain, arterial wounds or gangrene)
- Active skin or limb infection/inflammatory disease (acute cellulitis, other uncontrolled skin or untreated inflammatory skin disease)
- Any circumstance where increased lymphatic or venous return is undesirable
- During pregnancy (applies only to the Flexitouch Plus Trunk garment)

**The head and vest garments for head and neck treatment with the Flexitouch Plus system should not be used if you have one or more of the following conditions:**

- Uncontrolled hyperthyroidism or parathyroidism (for which an endocrinologist recommends against neck compression)
- Carotid sinus hypersensitivity syndrome
- Symptomatic carotid artery disease, as manifested by a recent transient ischemic attack (within 30 days), ischemic stroke or amaurosis fugax (monocular visual ischemic symptoms or blindness)
- Symptomatic bradycardia in the absence of a pacemaker
- Internal jugular venous thrombosis (within 3 months)
- Increased intracranial pressure or other contraindication to internal or external jugular venous compression

- Acute radiation dermatitis, unhealed surgical scar, unhealed or open wound(s), surgical flap less than 6–8 week post-operative
- Facial or head and neck dermal metastasis
- Acute facial infection (e.g., facial or parotid gland abscess)
- Any condition in which increased venous and lymphatic return is undesirable

## 1.5 Unpacking Instructions

When your Flexitouch Plus system arrives, allow the controller unit to reach room temperature for one hour before using. It is important that you carefully unpack the contents and ensure that you have all the equipment required to begin operation.

Included in the box, you should find the following:

- Quick Start Guide(s)
- Controller unit
- Garments and accessories needed to treat your condition
- Power adapter
- Bilateral port adapter (if prescribed bilateral treatment)

The garments and accessories you receive will depend upon your individual treatment requirements.

If you are missing any of the items listed for your prescribed treatment, please text or call Customer Care at 612.355.5100 (toll free phone 833.3TACTILE), 7 a.m. to 7 p.m. CT, Monday–Friday.

## Lower Extremity Treatment

The garments and accessories needed for lower extremity treatment may include the following:

- ComfortEase Full Leg garment (x-short, short, medium or long)
- ComfortEase Trunk garment (small, medium, large or x-large)
- Flexitouch Plus Full Leg garment (short, medium or long)
- Flexitouch Plus Half Leg garment (regular or EXT)
- Flexitouch Plus Trunk garment (small, medium or large)
- Flexitouch Plus EXT Trunk-Thigh garment waist extender(s)

## Upper Extremity Treatment

The garments needed for upper extremity treatment may include the following:

- ComfortEase Vest garment
- ComfortEase Vest and Arm(s) garment
- ComfortEase Trunk garment (small, medium, large or x-large)
- Flexitouch Plus Arm-Shoulder garment
- Flexitouch Plus Trunk garment (small, medium or large)

## Head and Neck Treatment

The garments needed for head and neck treatment may include the following:

- ComfortEase Vest garment
- ComfortEase Head garment
- Flexitouch Plus Vest garment
- Flexitouch Plus Head garment

## Labels

The garment label is located where the tubing attaches to the garment for Flexitouch Plus garments, and where indicated in **Figure 1.5.a.** for Flexitouch Plus with ComfortEase garments. The label indicates the type of garment you have – Flexitouch Plus with ComfortEase, or Flexitouch Plus – and the body area where the garment is to be applied (full leg, half leg, trunk, trunk-thigh, arm-shoulder, arm, vest or head) (**Figure 1.5.a.**).

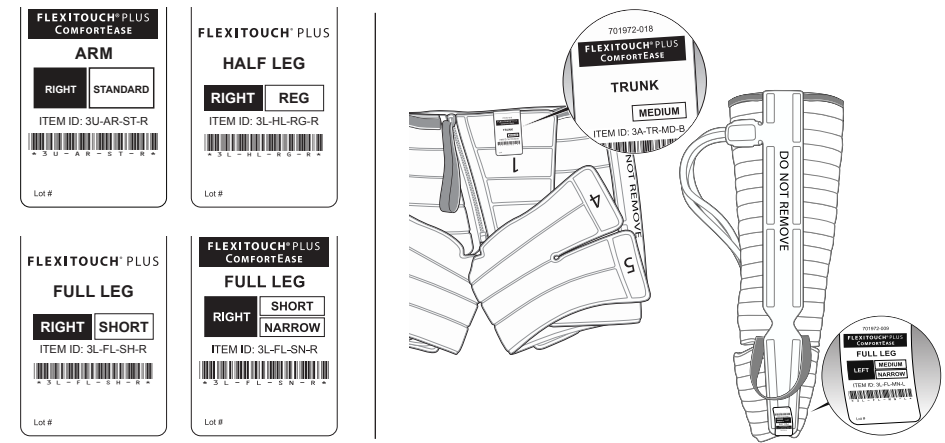


Figure 1.5.a. Label Examples

## 1.6 Kylee – Personal Lymphedema Assistant Mobile Application

Kylee is a free mobile application provided by Tactile Medical. With Kylee you can keep a record of your symptoms and at-home treatment sessions to help you track your therapy and progress. Kylee captures data by connecting your Flexitouch Plus system to your mobile device through wireless Bluetooth technology. Data is transmitted when your Flexitouch Plus device is on, the Kylee application is open and your mobile device is within Bluetooth range (33 ft.).

Kylee captures treatment and symptom information into an Activity Report that can be shared with your healthcare provider for insight into how your treatment is working. Learn more at [www.tactilemedical.com/kylee](http://www.tactilemedical.com/kylee).

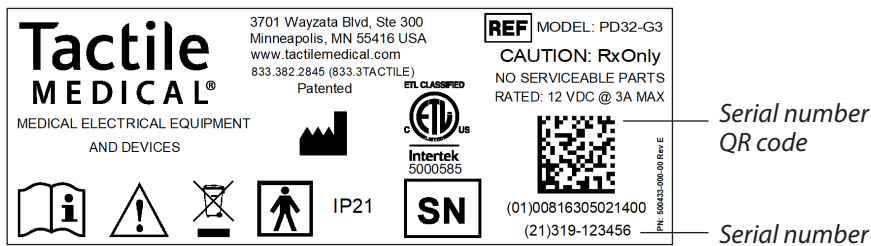


### Connecting Your Flexitouch Controller Unit to Kylee

To connect your Flexitouch Plus device to Kylee follow these steps:

1. Download Kylee from the Apple App Store, Google Play Store, or use your smartphone to scan the QR code above.
2. Create an account in Kylee.
3. Ensure you have the Bluetooth setting for your mobile device turned on.
4. Follow the step-by-step guide within Kylee to connect your Flexitouch Plus device to Kylee via Bluetooth.

**NOTE:** The serial number is located on the rear of your controller unit in the lower right-hand corner of the label, as shown in the example below. It can be scanned into Kylee by using the QR code or manually entered. The serial number is all numbers/letters after the parentheses.



### Flexitouch Plus Bluetooth Menu and Status Icon

On the main screen of your Flexitouch Plus device, navigate to the Device Status option and select Enter. Within Device Status, navigate to View Bluetooth Menu and select Enter to view options.

- **Toggle Bluetooth Power:** This turns the Bluetooth power off. Turning off Bluetooth power will prevent you from connecting your device to the Kylee mobile app.
- **Pair a Bluetooth Device:** This is used to connect your device to the Kylee mobile app. Kylee will walk you through this setup process within the app.
- **Remove Paired Device:** This is used to remove a previously paired Bluetooth connection.

### Bluetooth Status Icon

The Bluetooth icon is located on the top right corner of your Flexitouch Plus screen.

When Bluetooth power is off, the icon is gray (**Figure 1.6.a.**).

When Bluetooth power is on, the icon is blue (**Figure 1.6.b.**).

When data is being shared between the Flexitouch Plus device and Kylee, the icon is blue with three curved lines next to it (**Figure 1.6.c.**).

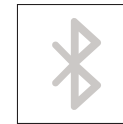


Figure 1.6.a.

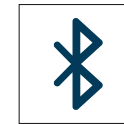


Figure 1.6.b.



Figure 1.6.c.

Status Displayed on Flexitouch Plus	Description
Disabled	Bluetooth power is turned off on the Flexitouch Plus device
Not Paired	Bluetooth power is on but the Flexitouch Plus device has not been paired with Kylee
Paired	Bluetooth power is on and the Flexitouch Plus device is successfully paired with Kylee
Connected	The Flexitouch Plus device is actively sending data to Kylee; this happens periodically and takes about 10 seconds

## The Flexitouch Plus System

The Flexitouch Plus system is an advanced pneumatic compression device clinically proven to stimulate the lymphatic system. The device helps direct and move excess fluid from an impaired lymphatic region to healthy regions, where fluid can be absorbed and processed naturally by your body.

Flexitouch Plus garment chambers inflate sequentially with each chamber inflating before the adjacent distal chamber fully deflates. This creates a dynamic wave of treatment that directs fluid into the lymphatic capillaries while maintaining distal pressure to prevent distal backflow.

**NOTE:** No special skills, training or knowledge are required to operate the Flexitouch Plus system.

### 2.1 System Components

The Flexitouch Plus system consists of two primary components: the controller unit and garments.

#### Controller Unit

The controller unit is a programmable pneumatic compressor with four connector outlets. Each connector has eight outflow ports to plug in garment hoses. Air passes through the hoses, delivering treatment through the sequential inflation and deflation of up to 32 air chambers in the garments. By selecting the appropriate treatment program, calibrated gradient pressure is delivered to the chambers and assists in moving excess fluid out of the affected limb(s).

#### Garments

The air-chambered garments are made of soft pliable fabric. They are designed to fit the contours of your body by wrapping around the limb(s) and attaching with hook and loop fasteners. A variety of upper and lower extremity treatment options are available to address your specific needs.

*The lower extremity garment(s) are used to treat the leg(s) and core. Depending on your clinical needs, you may be prescribed a leg garment (or leg garments), or both a leg garment (or leg garments) and a trunk garment.*

*The upper extremity garment(s) and accessories are used to treat the arm(s), chest and core. Depending on your clinical needs, you may be prescribed an arm-shoulder garment, a vest garment, a combined vest/arm(s) garment or a trunk garment.*

*The head and neck garment and vest(s) for head and neck treatment are used to treat the head, neck and chest. Depending on your clinical needs, you may be prescribed a head and neck garment and a vest garment for head and neck treatment.*

### 2.2 Programmed Pressure Levels

Programmed pressure levels in each of the air chambers are based on physiological principles of how lymph fluid moves through the system. Your healthcare provider will determine what individual programs are appropriate for you. In certain medical circumstances, your healthcare provider may wish to increase or decrease the pressure settings. The Flexitouch Plus controller unit allows for selection of INCREASED, NORMAL or DECREASED pressure settings. If additional pressure adjustment is needed, individual treatment segments may be adjusted manually.

**NOTE:** Please consult with your healthcare provider before changing the pressure settings.

Refer to *Appendix A: Clinician-Directed Manual Pressure Adjustment*, for additional information on how to change pressures for the various treatment segments.

When using the various pressure modes or manually calibrating segmental pressures, the pressure gradient is maintained throughout each treatment segment. The most distal garment chambers hold a level of sustained pressure that is intended to prevent the distal backflow of lymph fluid. The treatments are designed only to deliver clinically appropriate pressures and maintain pressure gradients to prevent adverse device settings.

Table 1: Treatment Programs and Treatment Times for Flexitouch Plus Garments

Program	Program Display	Body Regions Treated	Treatment Time (min.)	Available Cycles
<b>Lower Extremity—Primary Treatment Programs</b>				
L1	Full Leg and Core	Trunk, Thigh, Calf and Foot	60	1
L9	Petite Leg and Core	Trunk, Thigh, Calf and Foot	52	1
L4	Full Leg Plus	Thigh, Calf and Foot	45	1–3
L5	Half Leg Plus	Calf and Foot	30	1–3
L7	Half Leg	Calf and Foot	30	1–3
L8	Full Leg	Thigh, Calf and Foot	45	1–3
<b>Lower Extremity—Supplemental Treatment Programs</b>				
L2	Trunk Only (Upward)	Trunk	16	1–3
L3	Trunk and Thigh	Trunk and Thigh	30	1–3
L6	Foot Only	Foot	16	1–3
<b>Upper Extremity—Primary Treatment Programs</b>				
U1	Full Arm and Core	Trunk, Chest, Shoulder, Biceps, Forearm and Hand	60	1
U4	Arm-Shoulder	Chest, Shoulder, Biceps, Forearm and Hand	50	1–3
U7	Full Arm	Shoulder, Biceps, Forearm and Hand	30	1–3
<b>Upper Extremity—Supplemental Treatment Programs</b>				
U2	Trunk Only (Downward)	Trunk	12	1–3
U3	Trunk and Chest	Trunk, Chest and Shoulder	30	1–3
U5	Forearm and Hand	Forearm and Hand	24	1–3
U6	Hand Only	Hand	12	1–3
<b>Head and Neck—Primary Treatment Program</b>				
H1	Head, Neck and Chest	Head, Neck and Chest	32	1
<b>Head and Neck—Supplemental Treatment Programs</b>				
H2	Head Only	Head and Neck	13	1–3
H3	Chest (Outward)	Chest	12	1–3

Table 2: Treatment Programs and Treatment Times for Flexitouch Plus with ComfortEase Garments

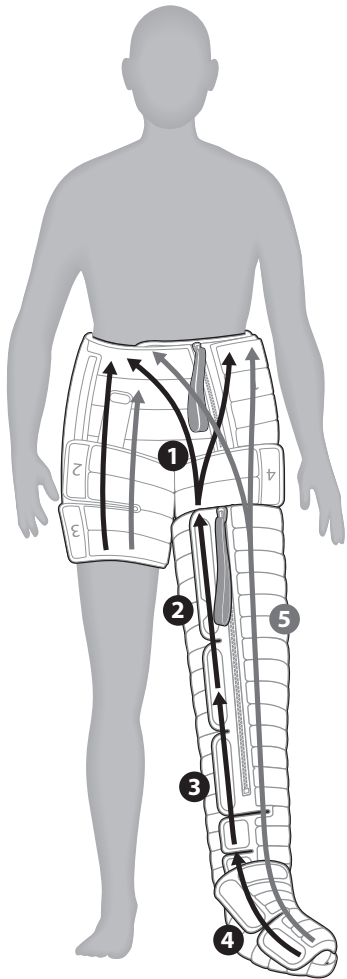
Program	Program Display	Body Regions Treated	Treatment Time (min.)	Available Cycles
<b>Lower Extremity—Primary Treatment Programs</b>				
CL1	Full Leg and Core	Trunk, Thigh, Calf and Foot	60	1
CL9	Petite Leg and Core	Trunk, Thigh, Calf and Foot	52	1
CL4	Full Leg Plus	Thigh, Calf and Foot	45	1–3
CL5	Half Leg Plus	Calf and Foot	30	1–3
CL7	Half Leg	Calf and Foot	30	1–3
CL8	Full Leg	Thigh, Calf and Foot	45	1–3
<b>Lower Extremity—Supplemental Treatment Programs</b>				
CL2	Trunk Only (Upward)	Trunk	16	1–3
CL3	Trunk and Thigh	Trunk and Thigh	30	1–3
CL6	Foot Only	Foot	16	1–3
<b>Upper Extremity—Primary Treatment Programs</b>				
CU1	Full Arm and Core	Trunk, Chest, Shoulder, Biceps, Forearm and Hand	60	1
CU4	Arm-Shoulder	Chest, Shoulder, Biceps, Forearm and Hand	50	1–3
CU7	Full Arm	Shoulder, Biceps, Forearm and Hand	30	1–3
<b>Upper Extremity—Supplemental Treatment Programs</b>				
CU2	Trunk Only (Downward)	Trunk	12	1–3
CU3	Trunk and Chest	Trunk, Chest and Shoulder	30	1–3
CU5	Forearm and Hand	Forearm and Hand	24	1–3
CU6	Hand Only	Hand	12	1–3
CU8	Chest (Inward)	Chest and Shoulders	12	1–3
<b>Head and Neck—Primary Treatment Program</b>				
CH1	Head, Neck and Chest	Head, Neck and Chest	32	1
<b>Head and Neck—Supplemental Treatment Programs</b>				
CH2	Head Only	Head and Neck	13	1–3
CH3	Chest (Outward)	Chest	12	1–3

## 2.3 Treating the Lower Extremity

### Primary Treatment Program L1/CL1: Full Leg and Core

This option delivers treatment to both the leg and trunk regions when clinically appropriate. It provides incremental proximal clearing of lymphatic fluid in the ① trunk, ② thigh, ③ calf and ④ foot regions, followed by a traditional ⑤ full leg and trunk treatment (**Figure 2.3.a.**).

Treatment time: 60 minutes.



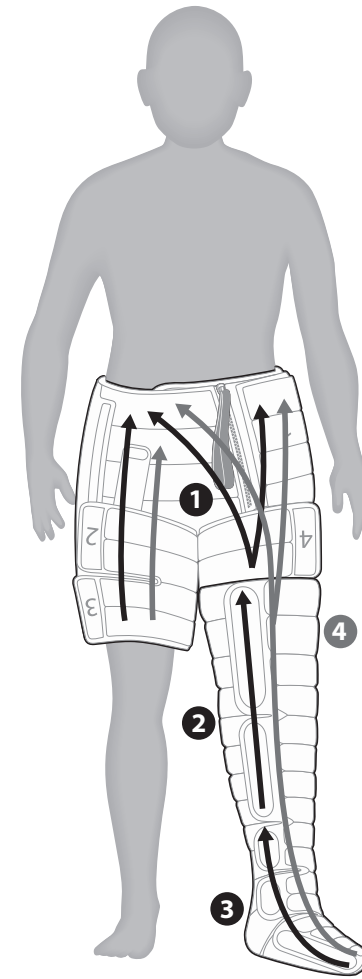
**Figure 2.3.a. Full Leg and Core**

- 1. Trunk**  
directs fluid from top of the thigh toward waist
- 2. Thigh**  
directs fluid from knee toward top of the thigh
- 3. Calf**  
directs fluid from ankle toward knee
- 4. Foot**  
directs fluid from toes toward ankle
- 5. Full Leg and Trunk**  
directs fluid from toes toward top of waist in one continuous motion

### Primary Treatment Program L9/CL9: Petite Leg and Core

This option delivers treatment to both the leg and trunk regions when clinically appropriate. It provides incremental proximal clearing of lymphatic fluid in the ① trunk, ② thigh, calf and ③ foot regions, followed by a traditional ④ half leg and trunk treatment (**Figure 2.3.b.**).

Treatment time: 52 minutes.



**Figure 2.3.b. Petite Leg and Core**

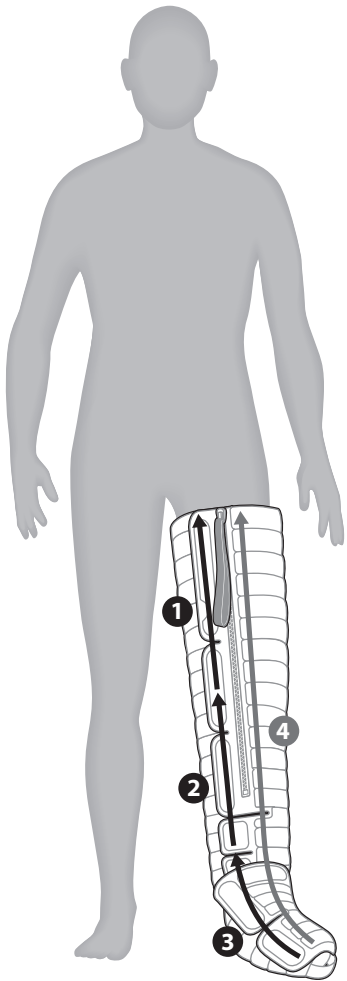
- 1. Trunk**  
directs fluid from top of the thigh toward waist
- 2. Calf**  
directs fluid from ankle toward top of the thigh
- 3. Foot**  
directs fluid from toes toward ankle
- 4. Full Leg and Trunk**  
directs fluid from toes toward top of waist in one continuous motion



### Primary Treatment Program L4/CL4: Full Leg Plus

This option delivers treatment to the leg when clinically appropriate. It provides incremental proximal clearing of lymphatic fluid in the ❶ thigh, ❷ calf and ❸ foot regions, followed by a traditional ❹ full leg treatment (**Figure 2.3.c.**).

Treatment time: 45 minutes.



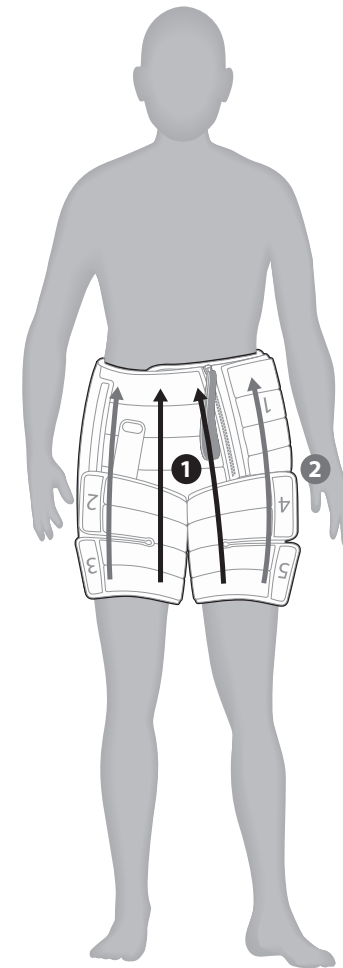
**Figure 2.3.c. Full Leg Plus**

- 1. Thigh**  
directs fluid from knee toward top of thigh
- 2. Calf**  
directs fluid from ankle toward knee
- 3. Foot**  
directs fluid from toes toward ankle
- 4. Full Leg**  
directs fluid from toes toward top of thigh in one continuous motion

### Supplemental Treatment Program L2/CL2: Trunk Only (Upward)

This option delivers treatment to the trunk region when clinically appropriate. It provides incremental proximal clearing of lymphatic fluid in the ❶ trunk region (**Figure 2.3.d.**).

Treatment time: 16 minutes.



**Figure 2.3.d. Trunk Only (Upward)**

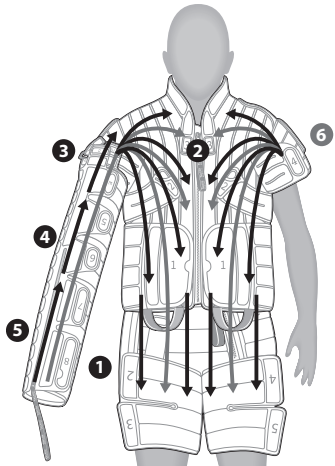
- 1. and 2. Trunk**  
directs fluid upward from top of the thigh toward top of the waist in one continuous motion

## 2.4 Treating the Upper Extremity

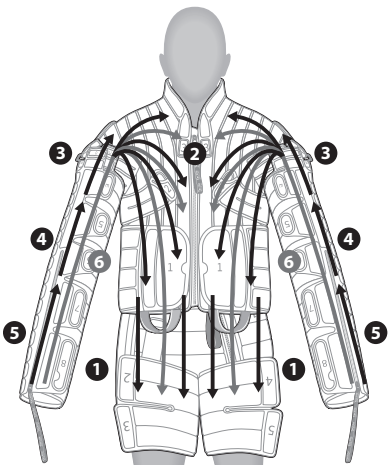
### Primary Treatment Program U1/CU1: Full Arm and Core

This option delivers treatment to the arm, chest and trunk regions when clinically appropriate. It provides incremental proximal clearing of lymphatic fluid in the ❶ trunk, ❷ chest, ❸ biceps, ❹ forearm and ❺ hand regions, followed by a traditional ❻ full arm, shoulder and chest treatment (**Figure 2.4.a.**).

Treatment time: 60 minutes.



Unilateral Treatment



Simultaneous Bilateral Treatment

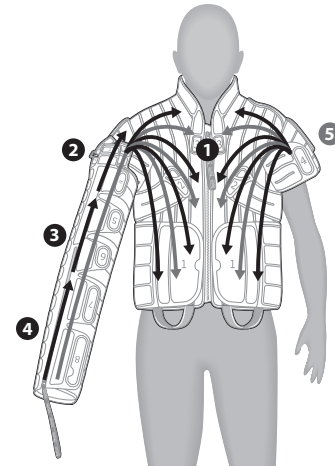
Figure 2.4.a. Full Arm and Core

1. **Trunk**  
directs fluid from waist toward top of thigh
2. **Chest**  
directs fluid from shoulder toward waist
3. **Biceps**  
directs fluid from elbow toward shoulder
4. **Forearm**  
directs fluid from wrist toward elbow
5. **Hand**  
directs fluid from fingers toward wrist
6. **Full Arm, Shoulder, Chest and Trunk**  
directs fluid from fingers up toward the shoulder, then toward the top of thigh in one continuous motion

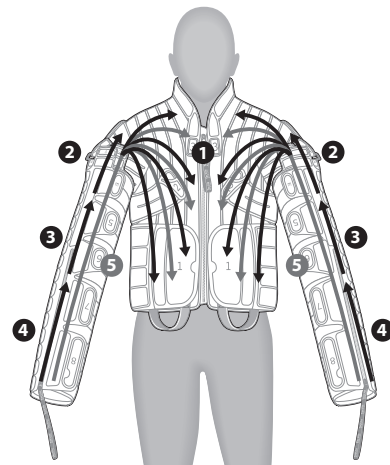
### Primary Treatment Program U4/CU4: Arm-Shoulder

This option delivers treatment to the arm and chest regions when clinically appropriate. It provides incremental proximal clearing of lymphatic fluid in the ❶ chest, ❷ biceps, ❸ forearm and ❹ hand regions, followed by a traditional ❺ full arm, shoulder and chest treatment (**Figure 2.4.b.**).

Treatment time: 50 minutes.



Unilateral Treatment



Simultaneous Bilateral Treatment

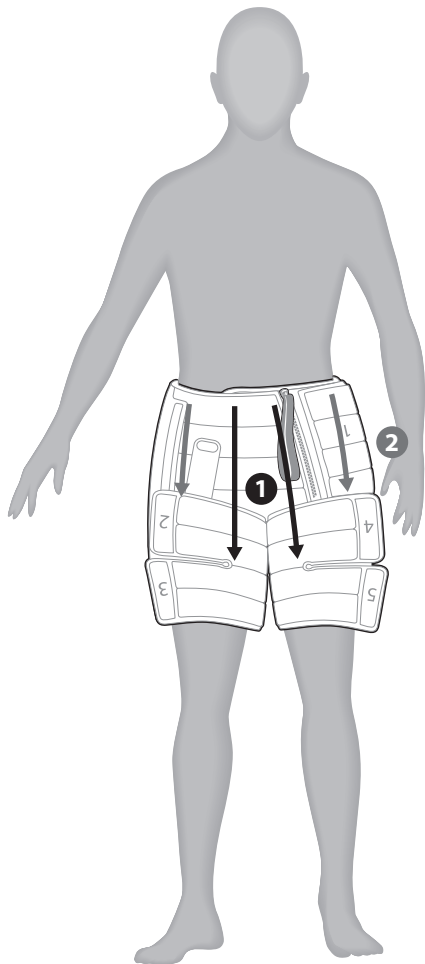
Figure 2.4.b. Arm-Shoulder

1. **Chest**  
directs fluid from shoulder toward waist
2. **Biceps**  
directs fluid from elbow toward shoulder
3. **Forearm**  
directs fluid from wrist toward elbow
4. **Hand**  
directs fluid from fingers toward wrist
5. **Full Arm, Shoulder and Chest**  
directs fluid from the fingers up toward the shoulder, then toward the top of the waist in one continuous motion

### Supplemental Treatment Program U2/CU2: Trunk Only (Downward)

This option delivers treatment to the trunk region when clinically appropriate. It provides incremental proximal clearing of lymphatic fluid in the ❶ trunk region (**Figure 2.4.c.**).

Treatment time: 12 minutes.



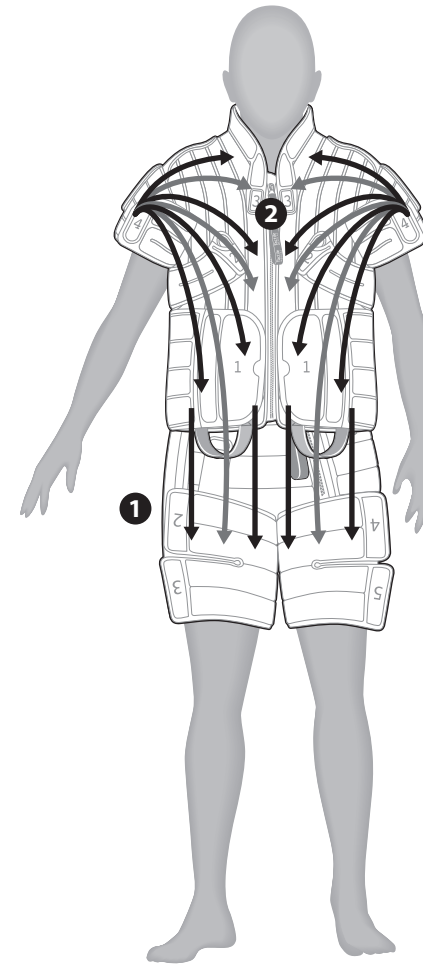
**Figure 2.4.c. Trunk Only (Downward)**

- 1. and 2. Trunk**  
directs fluid downward from top of the waist toward the top of the thigh in one continuous motion

### Supplemental Treatment Program U3/CU3: Trunk and Chest

This option delivers treatment to the trunk and chest regions when clinically appropriate. It provides incremental proximal clearing of lymphatic fluid in the ❶ trunk and ❷ chest, followed by a traditional ❸ shoulder, chest and trunk treatment (**Figure 2.4.d.**).

Treatment time: 30 minutes.



**Figure 2.4.d. Trunk and Chest**

- 1. Trunk**  
directs fluid from waist toward top of thigh
- 2. Chest**  
directs fluid from shoulder toward waist
- 3. Shoulder, Chest and Trunk**  
directs fluid from the shoulder, then toward the top of thigh in one continuous motion

## Supplemental Treatment Program CU8: Chest (Inward)

This treatment option provides the ability to deliver treatment to the chest region when clinically appropriate. Incremental proximal clearing of lymphatic fluid in the ❶ chest and shoulder regions (Figure 2.4.e.).

Treatment time: 12 minutes.

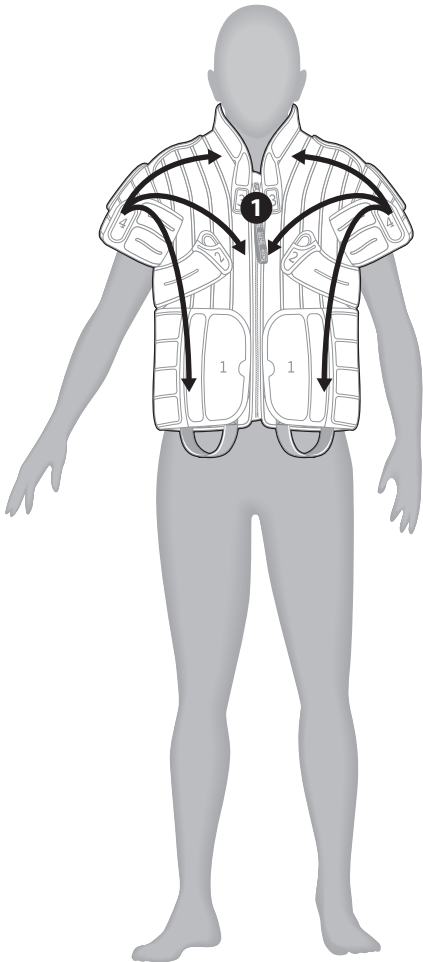


Figure 2.4.e. Chest (Inward)

- 1. Chest**  
directs fluid from shoulder toward waist

## 2.5 Treating the Head and Neck

### Primary Treatment Program H1/CH1: Head, Neck and Chest

This treatment option provides the ability to deliver treatment to the head, neck and chest when clinically appropriate. Incremental proximal clearing of lymphatic fluid in the ❶ chest, neck and ❷ head is followed by delivery of the ❸ full head, neck and chest treatment (Figure 2.5.a.).

Treatment time: 32 minutes.

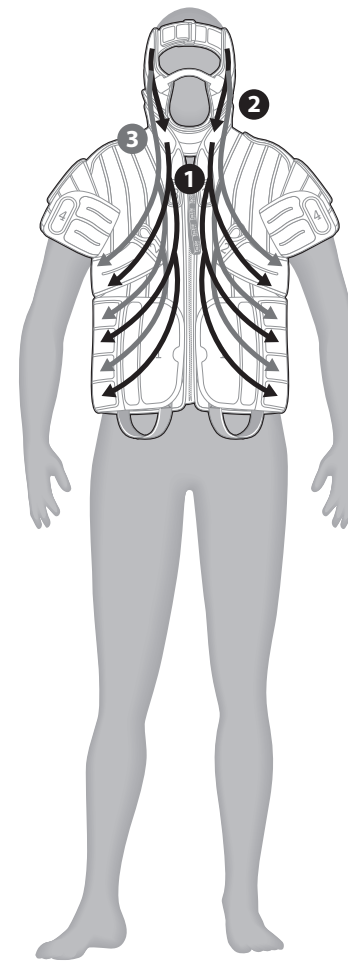


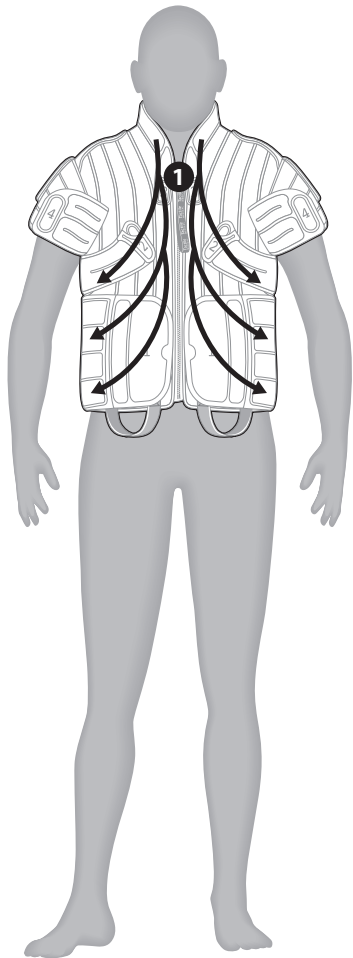
Figure 2.5.a. Head, Neck and Chest

- 1. Chest and Neck**  
directs fluid from the neck and the chest toward underarm area
- 2. Head**  
directs fluid from head toward neck
- 3. Head, Neck and Chest**  
directs fluid from head toward the underarm area in one continuous motion

## Supplemental Treatment Program H3/CH3: Chest (Outward)

This option delivers treatment to the chest region when clinically appropriate. It provides incremental proximal clearing of lymphatic fluid in the ❶ chest region (**Figure 2.5.b.**).

Treatment time: 12 minutes.



**Figure 2.5.b. Chest (Outward)**

- 1. Chest**  
directs fluid from the neck and the chest toward underarm area

## Controller Unit Setup

The Flexitouch Plus system consists of a controller unit, a garment set and accessories to treat your condition. In this chapter, you will learn how to set up the controller unit and select the proper settings prior to receiving treatment. You will learn how to apply the garments in Chapters 5 (trunk), 6 (lower extremity), 7 (upper extremity) and 8 (head and neck).

### 3.1 Setting Up Your Controller Unit

Follow the steps outlined below:

1. Find an appropriate location for the controller unit. Place the controller unit on a sturdy, flat surface near an electrical outlet. Position the device so you have easy access to the plug.
2. Plug the supplied power adapter into the power adapter inlet on the back of the controller unit. Then, plug the two-pronged plug into an electrical outlet (**Figure 3.1.a.**).

**NOTE:** There are two 12 VDC power adapter options, so the version shown in **Figure 3.1.a.** may be different from the one you receive. The two versions are:

- Meanwell GSM36U12-P1JNX
- Fuhua UE36LCP1-120300SPA

#### **WARNING: RISK OF ELECTRIC SHOCK**

Only use the Meanwell GSM36U12-P1JNX or Fuhua UE36LCP1-120300SPA power adapter with your Flexitouch Plus system. These power adapters are designed for use with either 120 Volt AC or 230 Volt AC outlets.

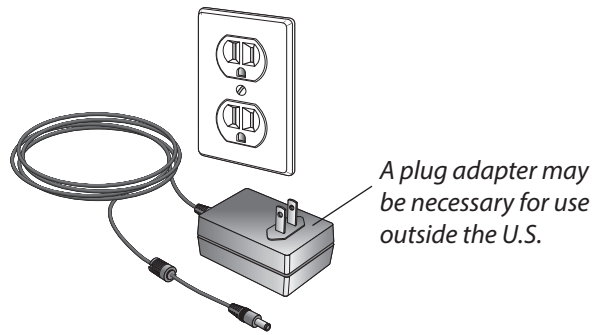



Figure 3.1.a. Power Adapter

### 3.2 Selecting Your Settings


Follow the steps outlined below to select the settings prescribed by your healthcare provider.

**NOTE:** Your controller unit will arrive programmed with your prescribed treatment saved as the first preset. You may not need to modify the preset program(s) unless instructed by your healthcare provider. The controller unit can, however, store up to three treatment therapies, and will automatically recall and highlight the last performed treatment.

#### Turn the controller unit ON.

1. Turn the controller unit on by pressing the  button located in the upper right corner on the front panel (**Figure 3.2.a.**).

#### Select and start your treatment session.

2. Your prescribed treatment program will be saved as the first preset on the home screen, and will be highlighted in blue when the controller unit is turned ON. To begin your prescribed treatment session, select the  button found on the right-hand side of the controller unit. Your treatment session will begin, and the time remaining will be displayed.

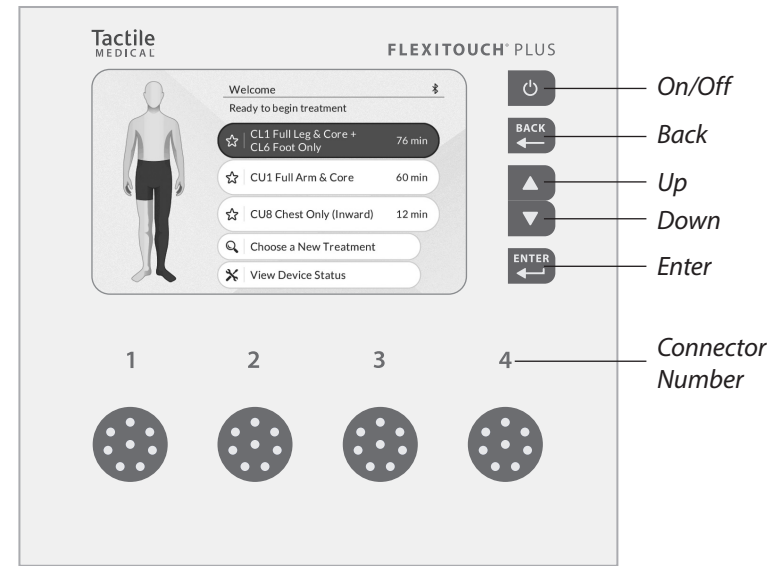














Figure 3.2.a. Controller Unit Front Panel

If you are prescribed a supplemental program, it will be saved as the second preset on your controller unit. To switch to the second preset and run the treatment program, press the  arrow button until the second preset is highlighted in blue. Once highlighted, select the  button to begin the supplemental treatment. Your treatment session will begin, and the time remaining will be displayed.

**NOTE:** You may PAUSE TREATMENT for up to 15 minutes at any point during a treatment session by pressing the  button. After that time, the controller unit will automatically shut off, requiring you to restart your treatment session. To resume your treatment, make sure the RESUME TREATMENT option is highlighted in blue, and press the  button. To stop treatment, press the  arrow button to select STOP TREATMENT and select .

#### Selecting or programming a new treatment.



3. On the home screen, press the  arrow button until the CHOOSE A NEW TREATMENT option is highlighted in blue. Once highlighted, select the  button. Using the  /  arrow buttons, and by pressing the  button when the appropriate option is highlighted in blue, complete the following:
  1. Select the appropriate TREATMENT REGION.
  2. Select the appropriate BODY TREATMENTS.
  3. Select the appropriate TREATMENT LOCATION.
  4. Select the prescribed TREATMENT PRESSURE.
  5. Select the number of TREATMENT CYCLES.
  6. Complete the treatment selection. Select DONE WITH SETUP using the  button if the treatment selection is complete. If you would like to string an additional treatment with the existing programmed treatment, select ADD ANOTHER TREATMENT and complete steps 2–5 above.
  7. Choose a preset to save the new treatment.

**NOTES:**

- *If you have three saved presets, you will need to overwrite one of them to save the new treatment.*
- *Please consult your healthcare provider before changing or adding programs to your prescribed treatment.*

**After you have selected the necessary settings, you are ready to connect the hoses to the controller unit.**

## Connecting Your Hoses to the Controller Unit

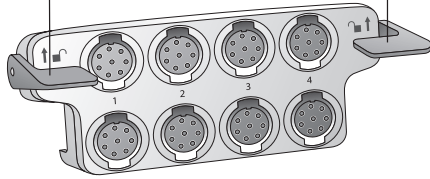
The next step is connecting your hoses to the controller unit. The hose latches and the ports on the controller unit/bilateral port adapter are numbered 1 through 4, so when connected properly, latch number 1 will connect to port number 1, and so on.

### 4.1 Connecting Your Bilateral Port Adapter

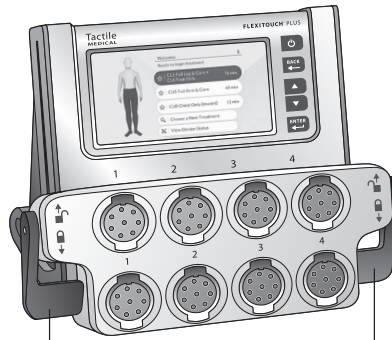
If you are conducting bilateral treatment, you will have received a bilateral port adapter that connects to the controller unit (**Figure 4.1.a.**). The adapter must be connected to the controller unit prior to connecting your garments. To connect the adapter, position it so the paddles on both sides are perpendicular to the adapter and the ports on the back of the adapter align with the ports on the front of the controller unit (**Figure 4.1.a.**). You will hear two clicks, which confirm the ports have been properly aligned and connected. Once the adapter has been properly connected, move the paddles on both sides in the down direction, so they are locked (**Figure 4.1.b.**). You should not be able to remove the adapter from the controller unit without unlocking it.

**NOTE:** *One or more of the ports will be capped if your prescribed treatment does not use the port(s). Do not remove the port cap(s).*

Ensure paddles are perpendicular to the adapter before attaching the bilateral port adapter to the controller unit



**Figure 4.1.a. Bilateral Port Adapter**

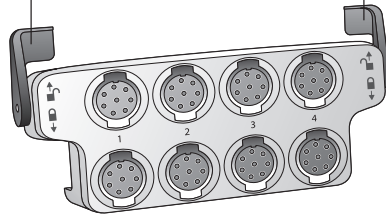


Once attached, move paddles to locked position

**Figure 4.1.b. Bilateral Port Adapter Attached to the Controller Unit**

To remove the bilateral port adapter, move the paddles on both sides all the way up to the unlock position (**Figure 4.1.c.**). With the paddles unlocked, pull the bilateral port adapter away from the face of the controller unit to remove it.

Move paddles up to the unlocked position, then pull adapter away from the face of the controller unit



**Figure 4.1.c. Removing the Bilateral Port Adapter**

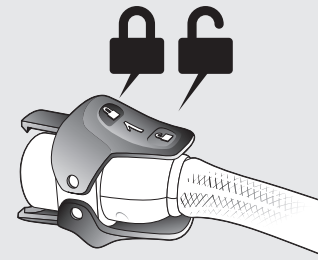
## 4.2 Connecting Your Flexitouch Plus Lock/Unlock Style Connectors to the Controller Unit

The Flexitouch Plus with ComfortEase has lock/unlock icons on the connectors (**Figure 4.2.a.**).

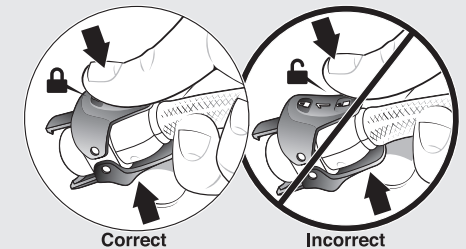


**Figure 4.2.a. Flexitouch Plus with ComfortEase Connector: Lock/Unlock Style**

1. Hold the connector with the number facing up. Put your thumb on the LOCK icon.



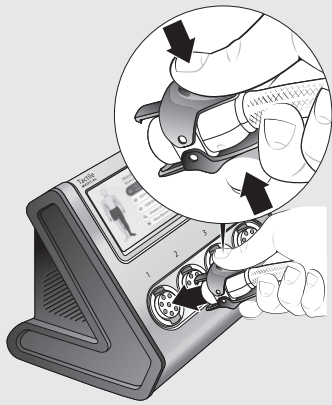
**Figure 4.2.b. Lock Icon and Numbering**



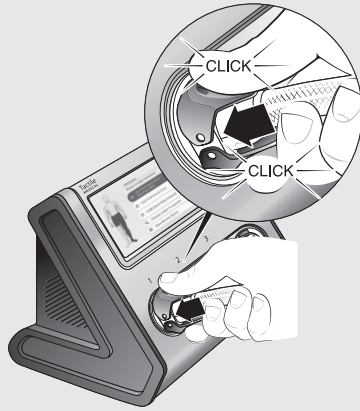
**Figure 4.2.c. Correct and Incorrect Way to Hold Connector for Hose Connection**

2. Line up the numbered latch with the port on the corresponding controller unit (**Figure 4.2.d.**).
3. Push the numbered latch forward onto the controller unit until you hear a “click.” This is how you will know each latch is properly connected. You may hear two clicks: one for the top and one for the bottom latch (**Figure 4.2.e.**).

**NOTE:** If the numbered latch is pushed very forcefully into the controller port, you may not hear a “click” sound.

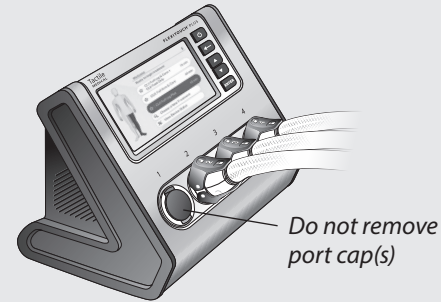


**Figure 4.2.d. Corresponding Hose Connector with Controller Unit Connector**

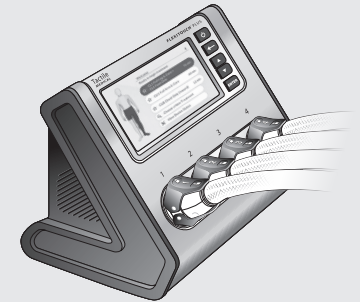


**Figure 4.2.e. Properly Connecting the Latches**

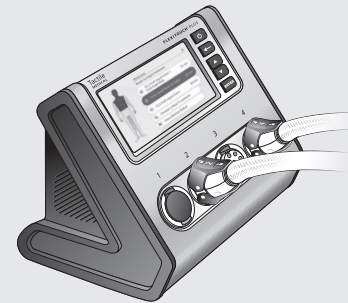
4. Repeat these steps for all connectors required for your prescribed treatment (**Figures 4.2.f., 4.2.g., 4.2.h., 4.2.i. and 4.2.j.**).



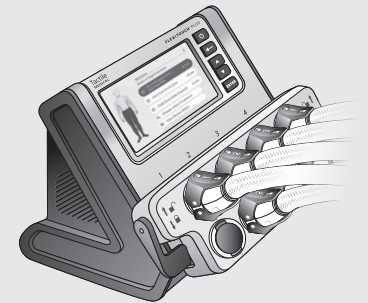
**Figure 4.2.f. Fully Attached Hose Connectors when Full Leg and Arm-Shoulder Treatments are Prescribed**



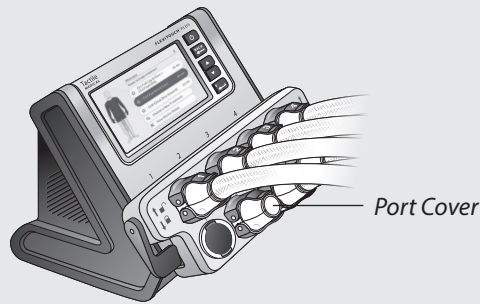
**Figure 4.2.g. Fully Attached Hose Connectors when both Extremity and Core Treatment are Prescribed**



**Figure 4.2.h. Fully Attached Hose Connectors when Head and Neck Treatment is Prescribed**



**Figure 4.2.i. Fully Attached Hose Connectors when Bilateral Port Adapter is Attached for Lower Extremity Treatment**



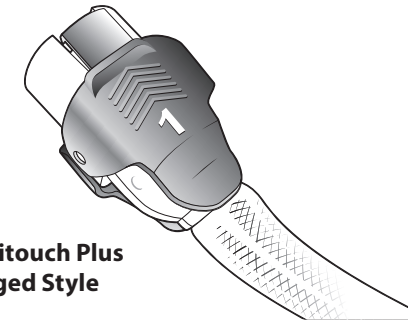
**Figure 4.2.j. Fully Attached Hose Connectors when Bilateral Port Adapter is Attached for Upper Extremity Treatment**

**NOTES:**

- Holding the back of the controller unit may help to stabilize the unit as you attach the latch connectors. If you are having trouble connecting the latches, try connecting the bottom latch first then tipping the top latch into place.
- You may see black numerical markings through the tubing. This is normal and does not affect performance.

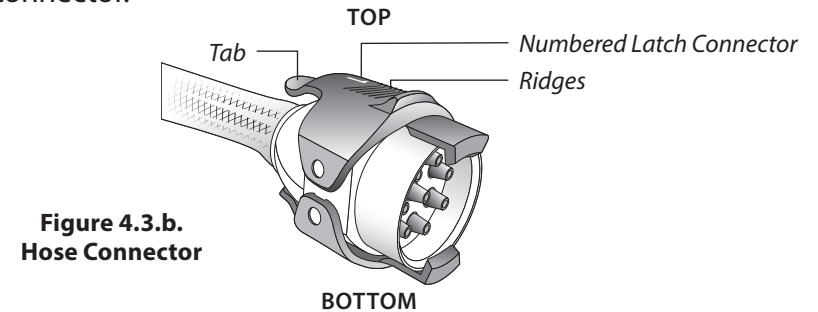
**4.3 Connecting Your Flexitouch Plus Hoses to the Controller Unit – Ridged Style**

The Flexitouch Plus has ridges on the connectors (**Figure 4.3.a.**).



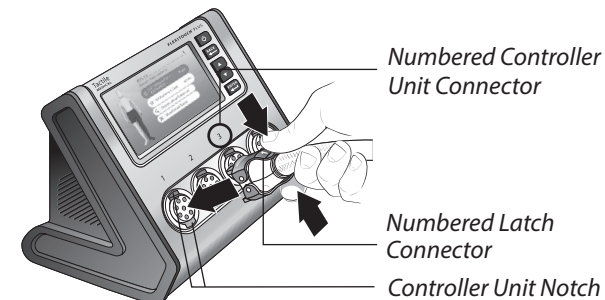
**Figure 4.3.a. Flexitouch Plus Connector: Ridged Style**

1. Hold the hose connector by the tabs on the back of the latch, making sure the numbers are facing up (**Figure 4.3.b.**).
2. Gently squeeze the tabs to widen the front end of the hose connector.



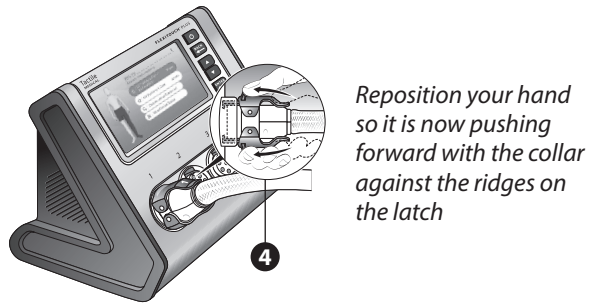
**Figure 4.3.b. Hose Connector**

3. Align the numbered latch with the notch on the corresponding controller unit notch (**Figure 4.3.c.**).



**Figure 4.3.c. Corresponding Hose Connector with Controller Unit Connector**

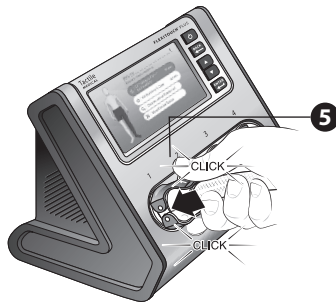
4. Reposition your hand so your thumb and fingers are positioned on the top and bottom latch ridges. This enables you to slide the latch (#4 in **Figure 4.3.d.**)



Reposition your hand so it is now pushing forward with the collar against the ridges on the latch

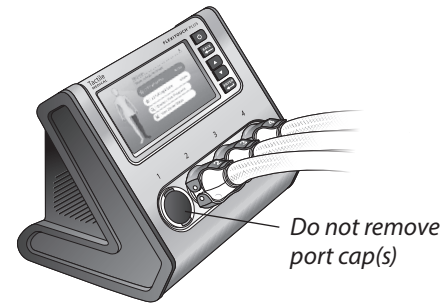
**Figure 4.3.d. Proper Handling of the Hose Connector**

5. Push the latch forward. It will hook on the top and bottom of the controller unit connector. You should hear a click when each of the latches is properly connected. Two clicks will be heard, one for the top and one for the bottom latch (#5 in **Figure 4.3.e.**)

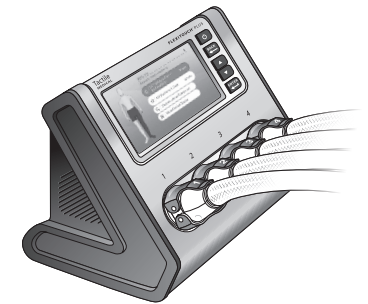


**Figure 4.3.e. Properly Connecting the Latches**

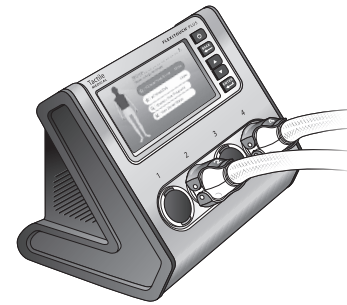
6. Repeat for all connectors required for your prescribed treatment (**Figures 4.3.f., 4.3.g., 4.3.h. and 4.3.i.**)



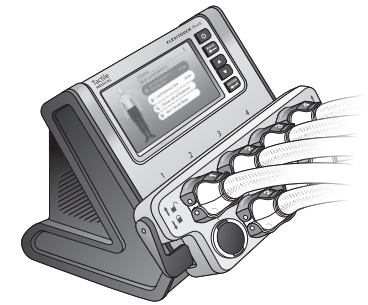
**Figure 4.3.f. Fully Attached Hose Connectors When Full Leg and Arm-Shoulder Treatments are Prescribed**



**Figure 4.3.g. Fully Attached Hose Connectors When Both Extremity and Core Treatments are Prescribed**



**Figure 4.3.h. Fully Attached Hose Connectors When Head and Neck Treatment is Prescribed**



**Figure 4.3.i. Fully Attached Hose Connectors When Bilateral Port Adapter is Attached**

**NOTES:**

- Holding the back of the controller unit may help to stabilize the unit as you attach the latch connectors. If you are having trouble connecting the latches, try connecting the bottom latch first then tipping the top latch into place.
- You may see black numerical markings through the tubing. This is normal and does not affect performance.

**You are now ready to apply your garment set as the final step before delivery of treatment.**



## Trunk Garment Application

Complete the following steps prior to starting treatment.

1. Make sure you are using the recommended garments and accessories.
2. Choose a treatment time with limited interruptions to avoid pausing treatment. Sessions typically last one hour.
3. Determine the type of trunk garment you have:
  - Flexitouch Plus with ComfortEase (see **Section 5.1**)
  - Flexitouch Plus (see **Section 5.2**)

Refer to the label to determine which garment you have.

### CAUTION

To avoid skin irritation that may result from contact with the nylon material, wear lightweight, loose-fitting (non-elastic) cotton clothing (example: scrubs, stockinette); for head and neck garments, use a face mask or balaclava. If skin irritation develops, consult with your healthcare provider.

It is recommended that you wear an undergarment to avoid potentially pinching skin with zipper.

Lymph fluid is moved through the vessels in the skin. It is important to avoid wearing anything during treatment that may hamper the lymph flow. These items include:

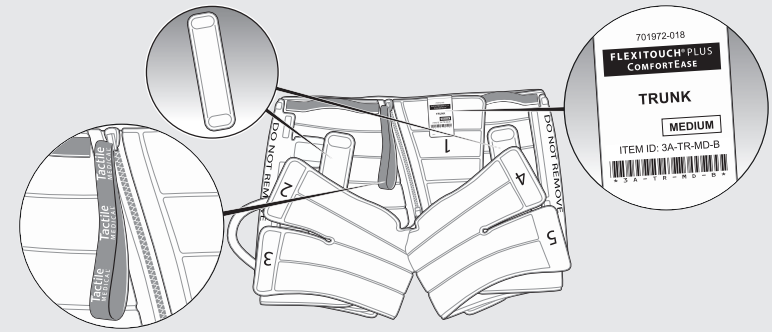
- **Belts**
- **Jewelry**
- **Restrictive clothing, such as:** elastic-banded underwear, compression bandaging, elastic-banded socks, compression garments or bra

### CAUTION

- The Flexitouch Plus garments should not be placed in direct contact with an open wound. It is recommended that wounds be properly dressed before the garment is applied. Contact your healthcare provider if you have any questions.
- Take care to avoid overheating when donning or doffing garments.

## 5.1 Applying Your Flexitouch Plus with ComfortEase Trunk Garment

These instructions apply to the trunk garment pictured in **Figure 5.1.a**.

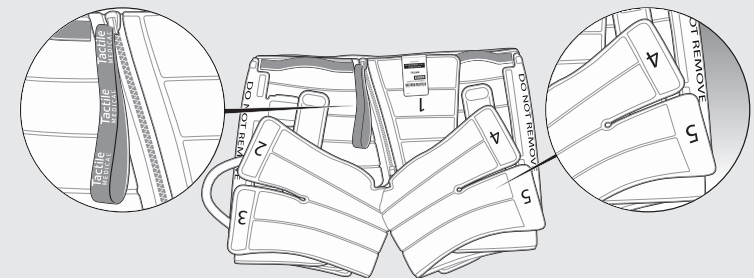


**Figure 5.1.a.**

### Preparing Your Trunk Garment for the First Time

1. Unfold and place your trunk garment on a bed or sofa so the thigh flaps and pocket closure are facing up and the hose is coming out to the right side of the trunk garment.

**NOTE:** The pocket closure is at the top of the trunk garment in the front and the thigh flaps are at the bottom. Locate the zipper on the front of the trunk garment (**Figure 5.1.b**).



**Figure 5.1.b.**



2. Open the pocket closure labeled 1. Sit down and slide your trunk garment on as you would a pair of shorts.
3. If your legs don't fit into your trunk garment, slide the trunk garment off and loosen the thigh tabs labeled 2 through 5 to allow you to slide your trunk garment on more easily.
4. Slide the trunk garment on and adjust the closure strap on your left thigh. Apply the pocket closure around your waist from right to left. Adjust the closure strap on your right thigh. You should be able to slide two fingers between your trunk garment and your waist to ensure an ideal fit (**Figures 5.1.c.** and **5.1.d.**).
5. Adjust the thigh flaps labeled 2 through 5 snugly around your thighs to get a well-contoured fit (**Figure 5.1.e.**). Make sure you have good contact at the groin area and the top of the trunk garment is around your abdomen.
6. Once you have achieved a snug fit, remove your trunk garment simply by unzipping the zipper in the front of the trunk garment and sliding it off like you would a pair of shorts. There is no need to undo the pocket closure or the thigh tabs.

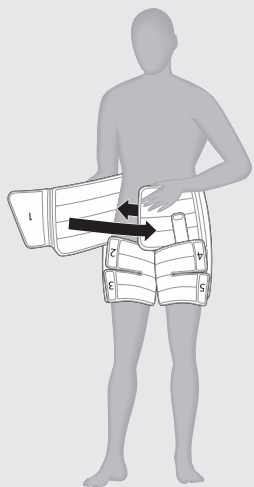


Figure 5.1.c.

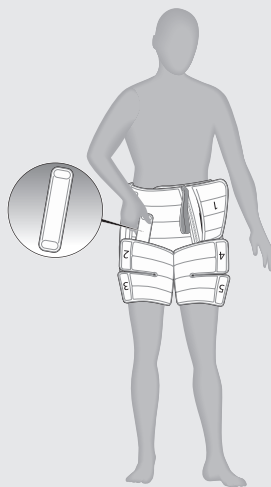


Figure 5.1.d.

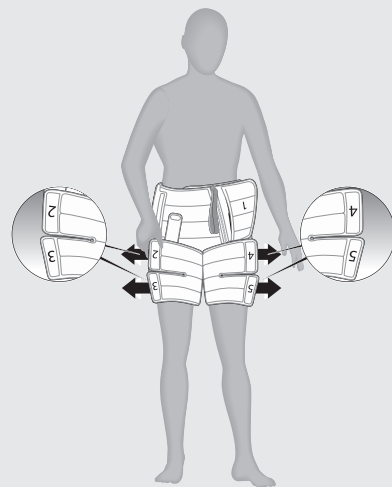


Figure 5.1.e.

## Applying Your Trunk Garment for Daily Treatment

7. Sit down and open the zipper on your trunk garment. Slide your trunk garment on as you would a pair of shorts. For best results, pull your trunk garment up as high as is comfortable, making sure you have good contact at the groin area. The top of the trunk garment should be around your abdomen (**Figure 5.1.f.**).
8. Use the zipper to zip up your trunk garment, ensuring a comfortable fit (**Figure 5.1.g.**).

**You are now ready to begin your treatment session. See Chapter 9 for further instructions.**

## Removing Your Trunk Garment

9. To remove your trunk garment unzip the zipper and slide it off as you would a pair of shorts. There is no need to undo the pocket closure or the thigh tabs.

### NOTES:

- If your treatment requires the use of a leg garment, see **Chapter 6**.
- If your treatment requires the use of a vest or arm and vest garment, see **Chapter 7**.
- If your treatment requires the use of a head/neck garment, see **Chapter 8**.

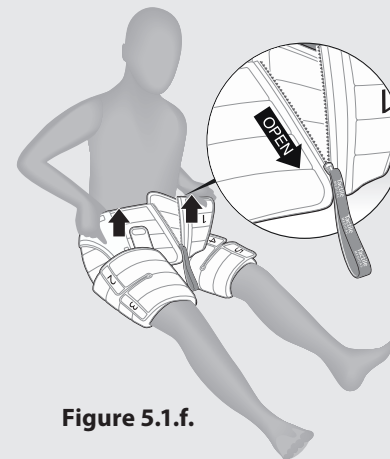


Figure 5.1.f.

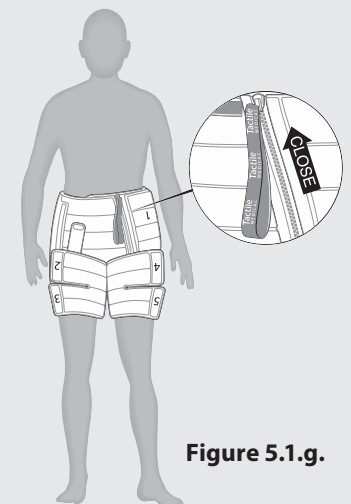


Figure 5.1.g.

## 5.2 Applying Your Flexitouch Plus Trunk Garment

These instructions apply to the trunk garment pictured in **Figures 5.2.a.** and **5.2.b.**

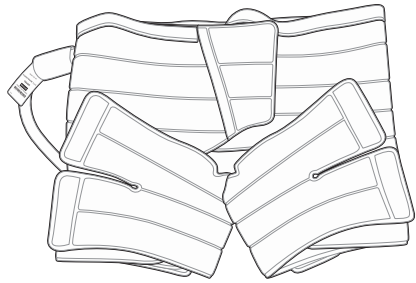


Figure 5.2.a.

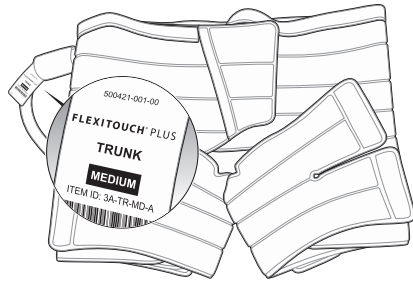


Figure 5.2.b.

### Preparing Your Trunk Garment

1. Unfold and place your trunk garment on a bed or sofa so the thigh flaps and pocket closure are facing up and the hose is coming out to the right. The pocket closure is at the top of the garment in the front and the thigh flaps are at the bottom.

### Applying Your Trunk Garment for Daily Treatment

2. Sit down and open the pocket closure to slide your garment on as you would a pair of shorts. Bring the inside flap of your trunk garment across your waist (#2 in **Figure 5.2.c.**). For best results, bring your trunk garment up as high as is comfortable – at least as high as your belly button.
3. Secure your trunk garment using the pocket closure (#3 in **Figure 5.2.d.**).
4. To get a well-contoured fit, undo the thigh flaps and wrap the garment snugly around your thigh (#4 in **Figure 5.2.d.**).

**You are now ready to begin your treatment session. See Chapter 9 for further instructions.**

### Removing Your Trunk Garment

5. To remove your trunk garment, simply open the pocket closure and slide the garment off as you would a pair of shorts.

### NOTES:

- If your treatment requires the use of a leg garment, see **Chapter 6.**
- If your treatment requires the use of a vest or arm and vest garment, see **Chapter 7.**
- If your treatment requires the use of a head/neck garment, see **Chapter 8.**

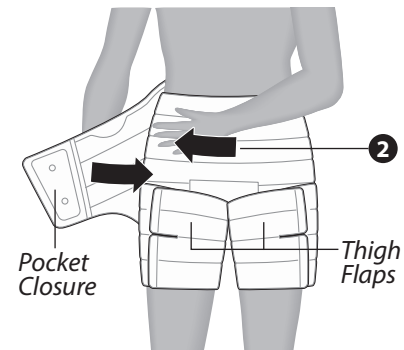


Figure 5.2.c. Trunk Garment Application

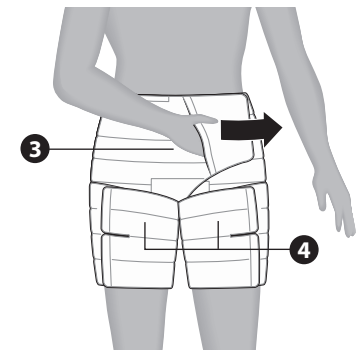


Figure 5.2.d. Securing the Trunk Garment

## Lower Extremity Garment Application

Complete the following steps prior to starting treatment.

1. Make sure you are using the recommended garments and accessories.
2. Choose a treatment time with limited interruptions to avoid pausing treatment. The treatment session typically lasts one hour.
3. Determine type of leg garment you have:
  - Flexitouch Plus with ComfortEase (see **Section 6.1**)
  - Flexitouch Plus (see **Section 6.2**)

Refer to the label to determine which garment you have.

**NOTE:** If your treatment requires the use of a trunk garment, see **Chapter 5, Section 5.1** first.

### CAUTION

To avoid skin irritation that may result from contact with the nylon material, wear lightweight, loose-fitting (non-elastic) cotton clothing (example: scrubs, stockinette); for head and neck garments, use a face mask or balaclava. If skin irritation develops, consult with your healthcare provider.

It is recommended that you wear an undergarment to avoid potentially pinching skin with zipper.

Lymph fluid is moved through the vessels in the skin. It is important to avoid wearing anything during treatment that may hamper the lymph flow. These items include:

- **Belts**
- **Jewelry**
- **Restrictive clothing, such as:** elastic-banded underwear, compression bandaging, elastic-banded socks, compression garments or bra

### CAUTION

- The Flexitouch Plus garments should not be placed in direct contact with an open wound. It is recommended that wounds be properly dressed before the garment is applied. Contact your healthcare provider if you have any questions.
- Take care to avoid overheating when donning or doffing garments.

## 6.1 Applying Your Flexitouch Plus with ComfortEase Full Leg Garment

These instructions apply to the full leg garments pictured in **Figures 6.1.a., 6.1.b.** and **6.1.c.**

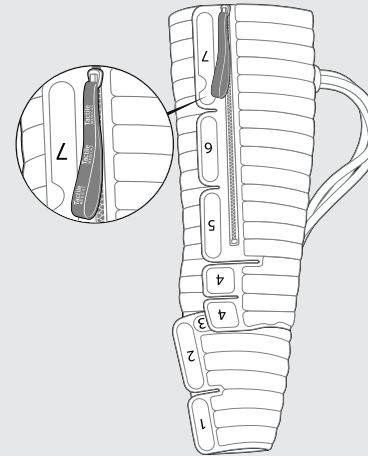


Figure 6.1.a.

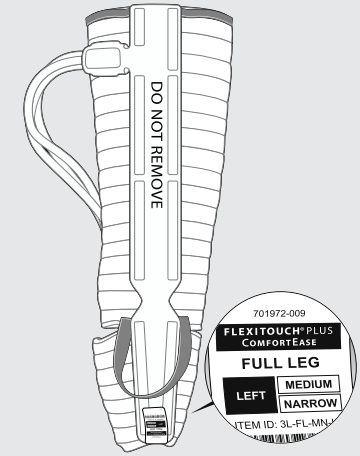


Figure 6.1.b.

### Preparing Your Full Leg Garment for the First Time

1. Unfold and place your full leg garment on a bed or sofa so the foot section is at the bottom and the tubing cover (labeled DO NOT REMOVE) runs along the back of your leg (**Figure 6.1.c.**).
2. If your full leg garment is already shaped like a boot, ensure the zipper is open, slide the garment on and proceed to step 4. To reshape your full leg garment like a boot, apply tabs 1 through 4. Ensure the zipper is open and slide your garment on just as you would a boot.

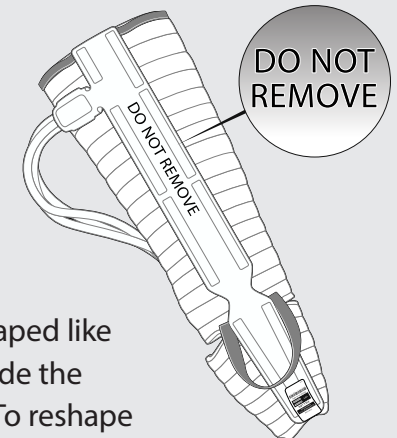


Figure 6.1.c.

3. Next, center your heel in the heel cup area where the foot section bends. Align the hoses along the back of your leg. Zip up your full leg garment (**Figure 6.1.d.**).
4. Adjust the numbered tabs 1 through 7 as necessary to get the desired fit, while being careful to minimize bunches and folding as best you can. You may need to remove your leg garment to adjust the tabs on your feet and ankles. You should be able to slide two fingers between the fabric and your thigh, and your toes should be fully covered by the garment and not sticking out of the end (**Figures 6.1.e. and 6.1.f.**).
5. Once you have achieved a snug fit, remove your leg garment by unzipping the zipper in the front and sliding it off as you would a boot. There is no need to undo the numbered tabs. To assist you in sliding your foot out of the full leg garment, you can hook your opposite foot in the heel garment on the leg strap. Alternatively, you can step firmly down on the heel strap with your opposite foot or grab the heel strap with a “reacher” (**Figure 6.1.g.**).

**NOTE:** For easier hose control during your treatment, you can “braid” the three hoses together and secure them with the gray closure strap attached to your leg garment.

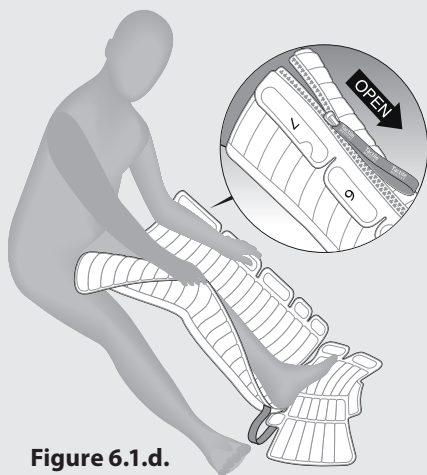


Figure 6.1.d.

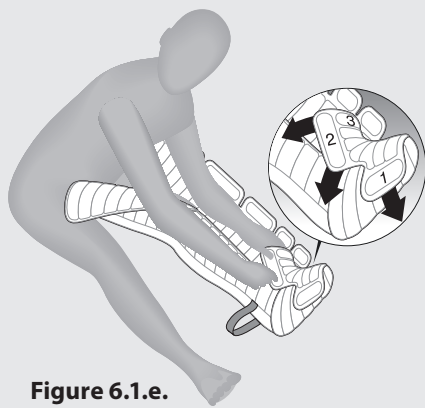


Figure 6.1.e.

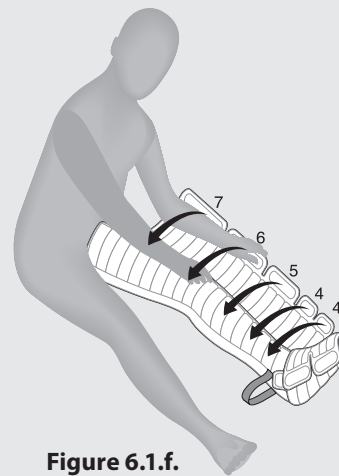


Figure 6.1.f.

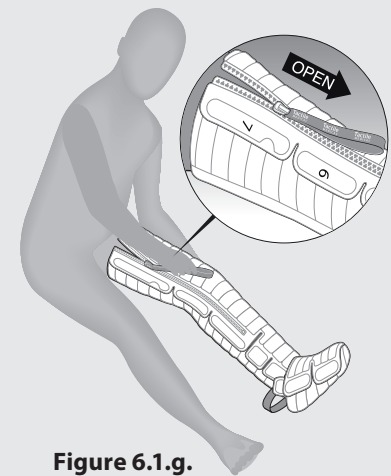


Figure 6.1.g.

### Applying Your Full Leg Garment for Daily Treatment

**NOTE:** If your treatment requires the use of a trunk garment, see **Chapter 5, Section 5.1.**

**NOTE:** If your treatment requires the use of a trunk garment, ensure your full leg garment overlaps your trunk garment to minimize gapping. If overlapped correctly, there should be no gap between your full leg garment and your trunk garment.

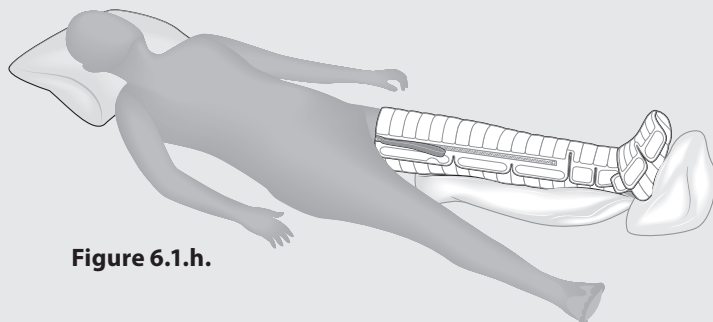
**NOTE:** This same overlap application applies to a half-leg garment and trunk garment for the L9/CL9 Petite Leg and Core treatment program.

Remember to zip up your full leg garment when you lay down to begin your session.

You will want two or three pillows within easy reach to place under your leg and head after you have put on your full leg garment.

1. Apply your full leg garment by laying it out on a bed, couch or recliner so the foot section is at the bottom and the tubing cover runs along the back of your leg (**Figure 6.1.h.**).
2. Ensure the zipper is open and slide your full leg garment on like you would a boot. Once your full leg garment is on, zip up the zipper and connect the hoses to the controller unit. Position a pillow under your leg to support the knee. Lie down (**Figure 6.1.h.**).

You are now ready to start your treatment session. **See Chapter 9: Conducting a Treatment Session** for details.



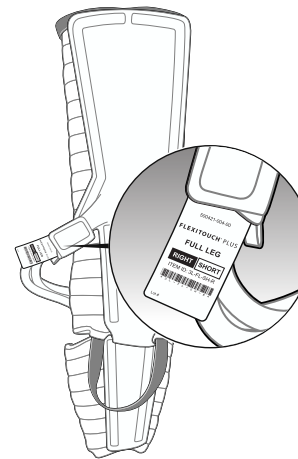
**Figure 6.1.h.**

### Removing Your Full Leg Garment

3. To remove your full leg garment, sit up, turn the controller unit off and disconnect your full leg garment hoses from the controller unit. Next, unzip and slide your leg garment off like a boot. To assist you in sliding your foot out of the full leg garment, you can hook your opposite foot in the heel strap on your leg garment. Alternatively, you can step firmly down on the heel strap with your opposite foot or grab the heel strap with a “reacher.”

## 6.2 Applying Your Flexitouch Plus Full Leg Garment

These instructions apply to the full leg garments pictured in **Figure 6.2.a.**



**Figure 6.2.a.**

### Preparing Your Full Leg Garment for the First Time

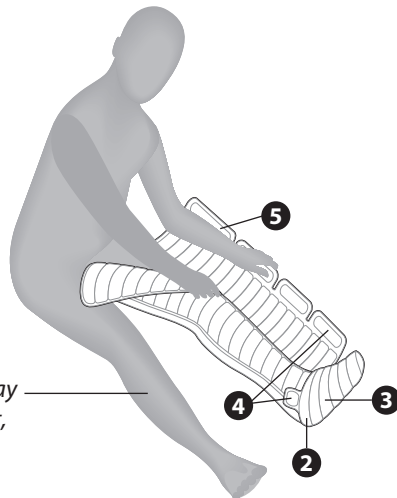
1. Unfold and place your full leg garment on the bed or sofa, so the foot section is at the bottom and the tubing cover runs along the back of your leg.
2. Sit down and place your leg on your garment. Center your heel in the heel cup area where the foot section bends (**#2 in Figure 6.2.b.**).
3. Contour the ankle section and secure the fabric in place with the hook fasteners (**#3 in Figure 6.2.b.**).
4. Unfasten the small tabs at the ankle section and secure the hook fasteners as you contour the foot section snugly around the arch of your foot and your toes. Continuing up your leg, readjust the ankle section, if necessary, and continue wrapping your lower calf, following its contours. Secure the fabric with the hook fastener tabs (**#4 in Figure 6.2.b.**).



- Continue to contour your garment using the hook fasteners for a secure fit up the calf and thigh (#5 in **Figure 6.2.b.**). When wrapping, try to minimize any bunches or folds in the fabric and adjust the hook fastener tabs as necessary to get a well-contoured fit.
- Finally, place a couple of pillows under your calf and foot to elevate them just above your hips for optimal treatment (#6 in **Figures 6.2.c.** and **6.2.d.**). Place the hoses alongside your body, so they are easy to reach when attaching them to the controller unit.

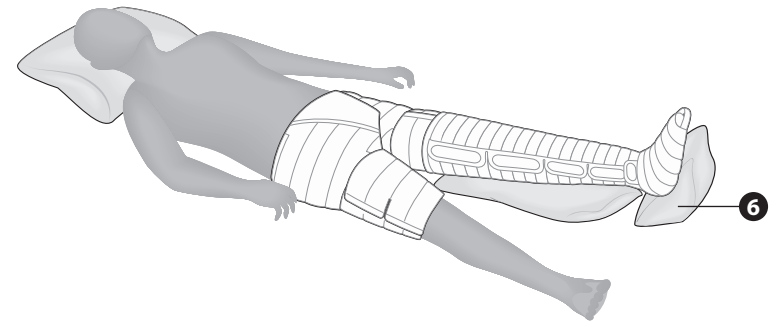
**NOTE:** After your leg garment has been configured for the first time, you should be able to slide it on as you would a boot. You should only need to open the hook fasteners above the knee when removing and reapplying the garment each time.

**NOTE:** If your treatment requires the use of a trunk garment, see **Chapter 5, Section 5.2.**

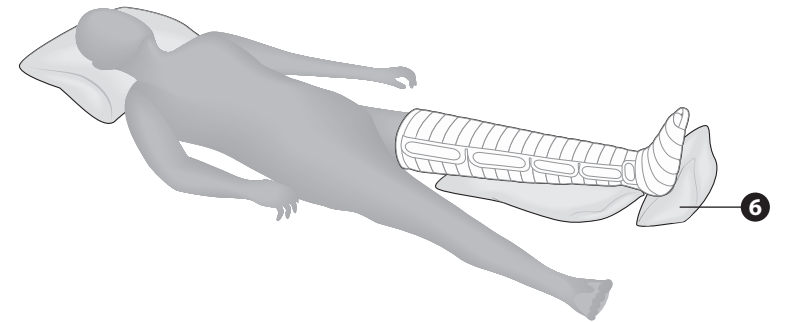


If you are treating both legs simultaneously, apply the second garment the same way you applied the first garment, following steps 2–5 above.

**Figure 6.2.b. Applying the Full Leg Garment**



**Figure 6.2.c. Fully Applied Full Leg Garment and Trunk Garment**



**Figure 6.2.d. Fully Applied Full Leg Garment**

**You are now ready to begin your treatment session. See Chapter 9 for further instructions.**

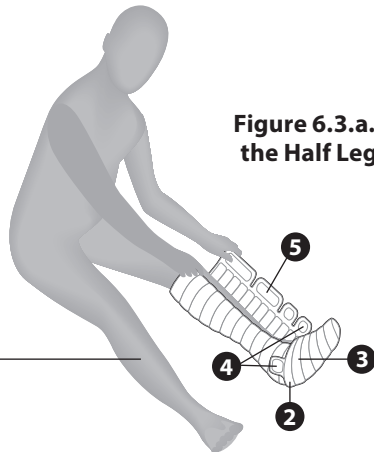


## 6.3 Applying Your Flexitouch Plus Half Leg Garment

### Preparing Your Half-Leg Garment for the First Time

1. Unfold and place your half leg garment on the bed or sofa. Position it so the foot section is at the bottom, and the tubing cover runs along the back of your leg.
2. Sit down and place your leg on the garment. Center your heel in the heel cup area where the foot section bends (#2 in **Figure 6.3.a.**).
3. Contour the ankle section and secure the fabric in place with the hook fasteners (#3 in **Figure 6.3.a.**).
4. Unfasten the small tabs at the ankle section and secure the hook fasteners as you contour the foot section snugly around the arch of your foot and your toes. Continuing up your leg, readjust the ankle section, if necessary, and continue wrapping your lower calf, following its contours. Secure the fabric with the hook fastener tabs (#4 in **Figure 6.3.a.**).
5. Continue to contour the garment using the hook fasteners for a secure fit up the calf (#5 in **Figure 6.3.a.**). You may need to readjust the ankle area before continuing to contour up the calf. When wrapping, try to minimize any bunches or folds in the fabric and adjust the hook fastener tabs as necessary to get a well-contoured fit.

If you are treating both legs simultaneously, apply the second garment the same way you applied the first garment, following steps 2-5 on previous page

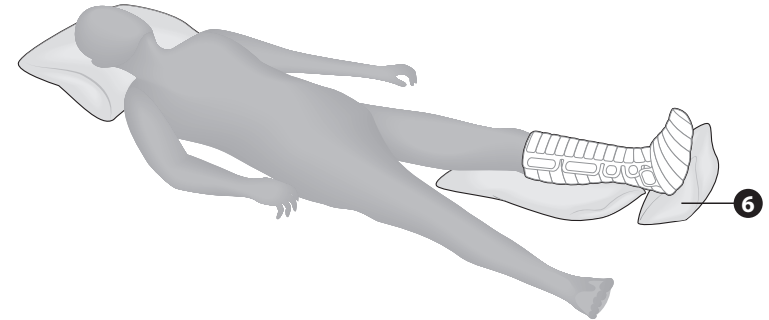


**Figure 6.3.a. Applying the Half Leg Garment**

6. Finally, place a couple of pillows under your calf and foot to elevate them just above your hips for optimal treatment (#6 in **Figure 6.3.b.**). Place the hoses alongside your body so they will be easy to reach when attaching them to the controller unit.

**NOTE:** After your half leg garment has been configured for the first time, you should be able to slide it on as you would a boot. You should only need to open the top hook fastener when removing and reapplying the garment each time.

**You are now ready to begin your treatment session. See Chapter 9 for further instructions.**



**Figure 6.3.b. Fully Applied Half Leg Garment**

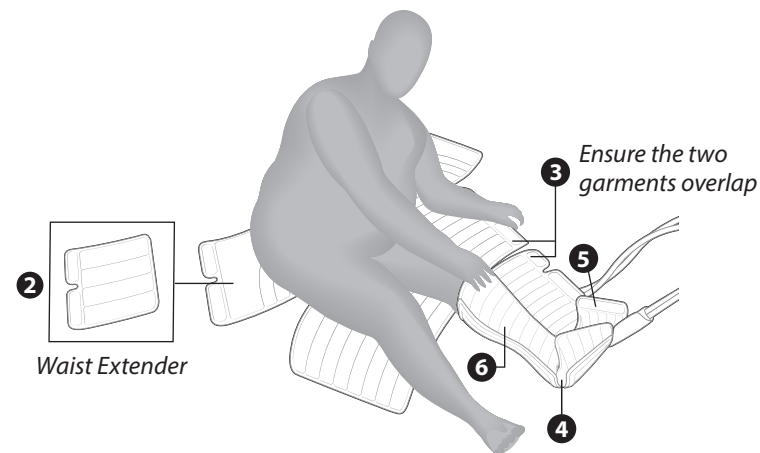
## 6.4 Applying Your Flexitouch Plus EXT Half Leg Garment and Trunk-Thigh Garment

### EXT Half Leg Garment and Trunk-Thigh Garment Preparation

1. Unfold and place your trunk-thigh garment on the bed or sofa. Position it so when you sit on it, the seam will be along the outside of your leg.
2. If you need a waist extender, attach it to the trunk garment (#2 in **Figure 6.4.a.**).
3. Place the half leg garment on the bed so that it overlaps the trunk-thigh garment by a couple of chambers and the seam runs along the back of your leg (#3 in **Figure 6.4.a.**).

### EXT Half Leg Garment Application

4. Sit down and place your heel into the heel cup area of the garment (#4 in **Figure 6.4.a.**).
5. Begin wrapping the foot section with the non-hook fastener side of the fabric. Snugly wrap the arch of the foot and the toes. Secure the fabric with the hook fastener tabs (#5 in **Figure 6.4.a.**).
6. Grasp the non-hook fastener side of the calf fabric. Wrap this section by starting mid-calf and move up and down your leg. Make sure the fabric is smooth and there are no gaps around the toes, ankle and knee. Secure the fabric with the hook fastener tabs, starting at the midpoint of the calf and continuing by attaching the hook fasteners up and down your calf (#6 in **Figure 6.4.a.**).
7. If necessary, readjust the fasteners to obtain a well-contoured and comfortable fit.



**Figure 6.4.a. Applying the Half Leg Garment**

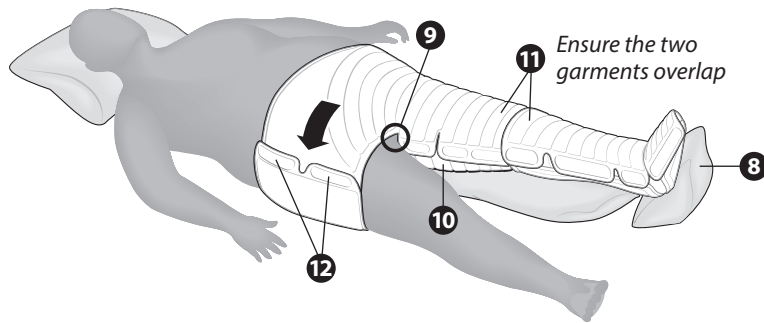
8. Place a couple of pillows under your calf and foot to elevate them just above your hips for optimal treatment (#8 in **Figure 6.4.b.**). Place the hoses alongside your body so they are easy to reach when you are ready to attach them to the controller unit.

### Trunk-Thigh Garment Application

9. Check to make sure the U-shaped notch on your trunk-thigh garment will be centered on the groin area when fully applied (#9 in **Figure 6.4.b.**).
10. Hold the non-hook fastener side of the thigh garment at the midpoint and bring it up between your thighs (#10 in **Figure 6.4.b.**). Starting mid-thigh, wrap this section over your thigh so that the fabric is snug and follows the crease where your thigh meets your trunk.

11. Grasp the hook fastener side of the thigh garment at the midpoint, wrapping it over the non-hook fastener fabric. Secure the hook fastener tabs, starting at the midpoint and working up and down your thigh. Adjust the hook fastener tabs as necessary to ensure a snug fit without gaps, paying particular attention to where the trunk-thigh garment and half leg garment meet (#11 in **Figure 6.4.b.**).
12. Lay back and snugly wrap the non-hook fastener side of the trunk fabric over your abdomen. Bring the hook fastener side of the fabric as far as you can over your trunk. Secure the hook fastener tabs (#12 in **Figure 6.4.b.**).

**You are now ready to begin your treatment session. See Chapter 9 for further instructions.**



**Figure 6.4.b. Fully Applied EXT Lower Extremity Garment Set**

## Upper Extremity Garment Application

Complete the following steps prior to starting treatment.

1. Make sure you are using the recommended garments and accessories to complete your treatment.
2. Choose a treatment time with limited interruptions to avoid pausing treatment. The treatment session typically lasts one hour.
3. Determine the type of garment you have:
  - Flexitouch Plus with ComfortEase Vest garment (see **Section 7.1**)
  - Flexitouch Plus with ComfortEase Arm garment (see **Section 7.2**)
  - Flexitouch Plus Arm-Shoulder garment (see **Section 7.3**)

Refer to the label to determine which garment you have.

**NOTE:** If your treatment requires the use of a trunk garment, see **Chapter 5, Section 5.1** first.

### CAUTION

To avoid skin irritation that may result from contact with the nylon material, wear lightweight, loose-fitting (non-elastic) cotton clothing (example: scrubs, stockinette); for head and neck garments, use a face mask or balaclava. If skin irritation develops, consult with your healthcare provider. It is recommended that you wear an undergarment to avoid potentially pinching skin with zipper.

Lymph fluid is moved through the vessels in the skin. It is important to avoid wearing anything during treatment that may hamper the lymph flow. These items include:

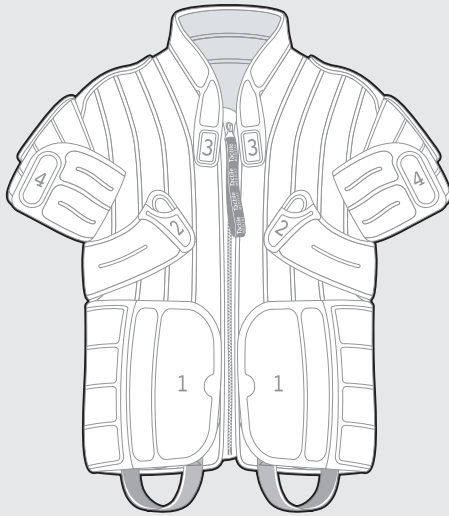
- **Belts**
- **Jewelry**
- **Restrictive clothing, such as:** elastic-banded underwear, compression bandaging, elastic-banded socks, compression garments or bra

### CAUTION

- The Flexitouch Plus garments should not be placed in direct contact with an open wound. It is recommended that wounds be properly dressed before the garment is applied. Contact your healthcare provider if you have any questions.
- Consult your healthcare provider before using Flexitouch Plus garments that cover the chest (arm-shoulder garment, and vest for head and neck garment) if you have a tissue expander.
- Take care to avoid overheating when donning or doffing garments.

## 7.1 Applying Your Flexitouch Plus with ComfortEase Vest Garment

These instructions apply to the vest garment pictured in **Figure 7.1.a**.



**Figure 7.1.a.**

**NOTE:** If your treatment requires the use of a trunk garment, see **Chapter 5, Section 5.1**.

**NOTE:** If your treatment requires the use of a trunk garment, ensure your vest garment overlaps the top of your trunk garment to minimize gapping. If overlapped correctly, there should be no gap between your vest garment and your trunk garment.

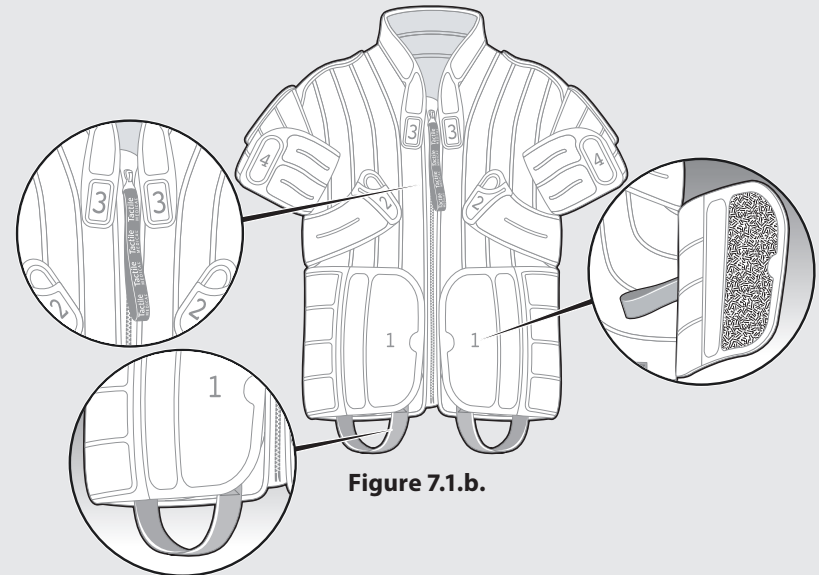
## Preparing Your Vest Garment for the First Time

1. Unfold and place your vest garment on a bed or sofa so the zipper and adjustment tabs labeled '1' through '4' are facing upward and the hose is visible.

**NOTE:** Take a moment to identify each of the following:

- The adjustment tabs labeled '1' located at the bottom of your vest garment.
- The adjustment tabs labeled '2' located under each armpit.
- The adjustment tabs labeled '3' located at the collar.
- The adjustment tabs labeled '4' located at each biceps.

In addition, take a moment to locate the zipper lanyard on the front of your vest garment, the black cinch straps under the adjustment tabs labeled '1,' and the black handle loops at the bottom of your vest garment on each side of the zipper (**Figure 7.1.b**).



**Figure 7.1.b.**

- Slide your vest garment on as you would a jacket, and use the zipper lanyard to zip your vest garment closed (**Figure 7.1.c.**). Put your thumbs through the black handle loops at the front bottom of your vest garment, and push downward to adjust positioning.
- Open the adjustment tabs labeled '1,' and attach each tab gently toward the rear of your vest garment – one on each side – so you are able to access the black cinch loops.

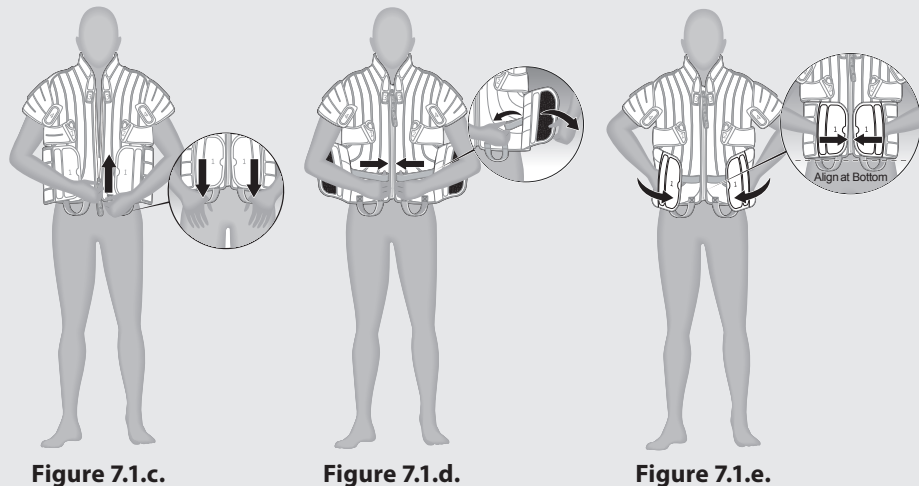
Detach both black cinch straps from your vest garment. Pull both straps forward at the same time toward the middle of your abdomen, without crossing your vest garment zipper, so that you feel a gentle – but not tight – contour at your lower back (**Figure 7.1.d.**).

- Locate the adjustment tabs labeled '1,' and detach them from your vest garment. Pull both tabs forward toward the front of your vest garment zipper, making sure not to overtighten the garment (**Figure 7.1.e.**).

When applied, these tabs should overlay the black cinch straps.

**NOTE:** In some cases, the end of the black cinch straps may be visible.

**NOTE:** Ensure the bottom of the adjustment tabs labeled '1' do not extend below your vest garment.



- Locate the adjustment tabs labeled '2' under each armpit and place your thumbs through the end of the tabs. Pull the tabs forward and slightly upward, one at a time, to achieve a snug fit under each armpit (**Figure 7.1.f.**).

**NOTE:** If you're unable to grab the adjustment tab labeled '2' with your corresponding hand, reach across with your opposite hand and pull across and upward to ensure a snug fit under your armpits (**Figure 7.1.g.**).

**NOTE:** If you have not been prescribed head and neck treatment, you do not need to adjust the adjustment tabs labeled '3' at your collar.

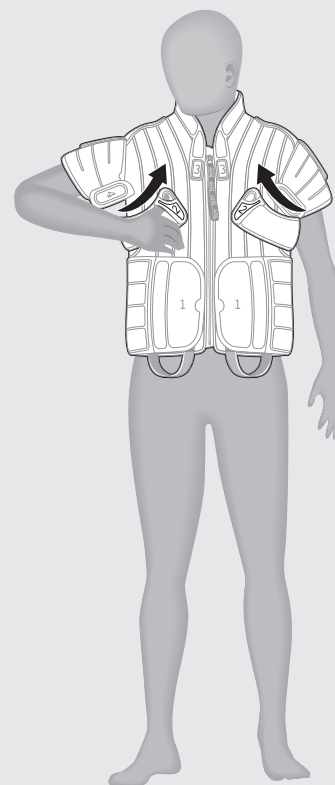


Figure 7.1.f.

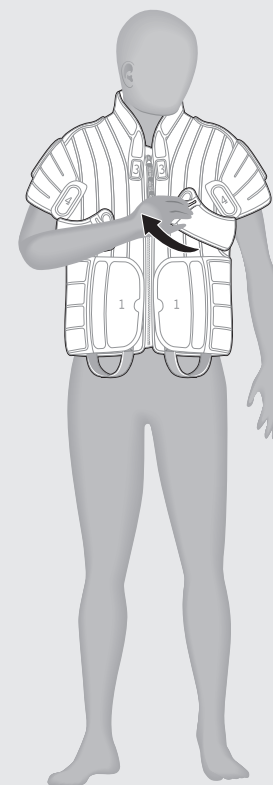
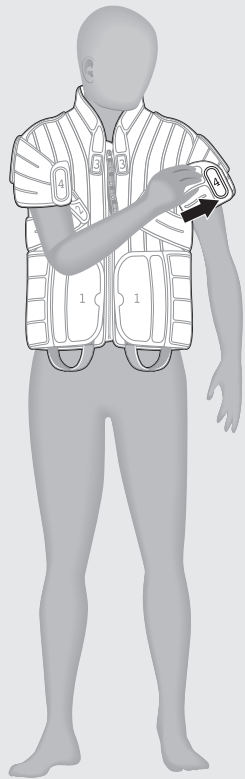


Figure 7.1.g.

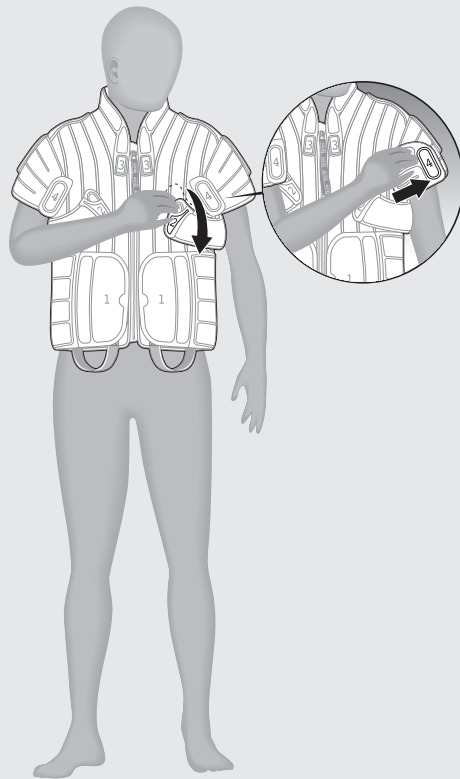
6. Locate the adjustment tabs labeled '4' on each arm. Detach each adjustment tab one at a time, and smooth the inner flap downward and around the underside of your biceps. Re-apply the adjustment tab labeled '4' by pulling it forward and upward around the front side of your biceps to achieve a snug fit (**Figure 7.1.h.**).

**NOTE:** If it is difficult to reach the adjustment tab labeled '4' on either arm, you may temporarily loosen the adjustment tabs labeled '2' on your chest. Next, reapply the adjustment tabs labeled '4,' and then reapply the adjustment tabs labeled '2' (**Figure 7.1.i.**).

**NOTE:** If the adjustment tab labeled '4' becomes fully unwound and is not easy to reach, lean forward and the tab should be easier to grasp.

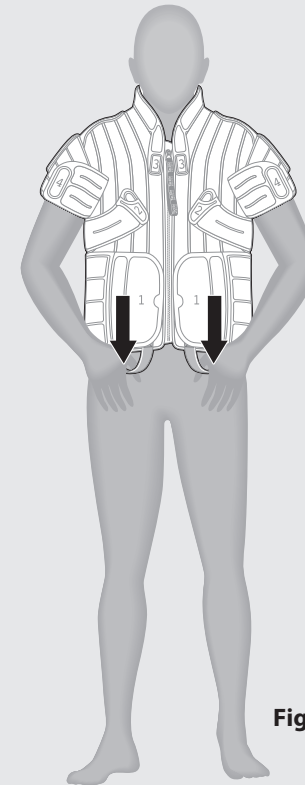


**Figure 7.1.h.**



**Figure 7.1.i.**

7. If necessary, once all adjustment tabs have been applied, locate the black handle loops at the front, bottom of your vest garment and push in a downward motion to adjust the positioning of your vest garment on your upper body (**Figure 7.1.j.**).



**Figure 7.1.j.**



### Applying Your Vest Garment for Daily Treatment

- Slide your vest garment on as you would a jacket. Zip closed your vest garment using the front zipper lanyard. Put your thumbs through the black handle loops at the bottom of your vest garment on each side of the zipper, and push downward to adjust positioning (**Figure 7.1.k.**).

When properly applied, your vest garment will follow the contours of your body.

**NOTE:** If your vest garment is too tight, you may need to readjust the black cinch straps slightly at your abdomen, or use the adjustment tabs labeled '1' through '4'.

**You are now ready to begin your treatment session. See Chapter 9 for further instructions.**

### Removing Your Vest Garment

- To remove your vest garment, unzip the front zipper pull. Locate the black handle loops at the front bottom of your vest garment. Using your thumbs, push downward while rolling your shoulders outward to remove your vest garment like a jacket (**Figure 7.1.l.**).

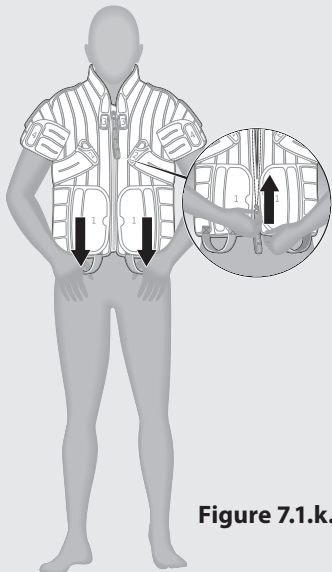


Figure 7.1.k.

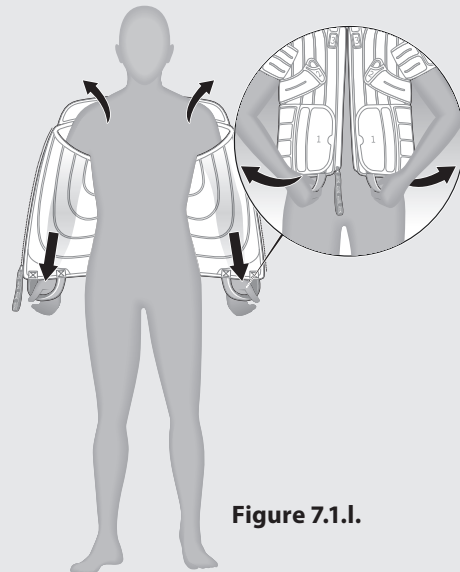


Figure 7.1.l.

### 7.2 Applying Your Flexitouch Plus with ComfortEase Vest and Arm Garment

These instructions apply to the vest and arm garment pictured in **Figure 7.2.a.**

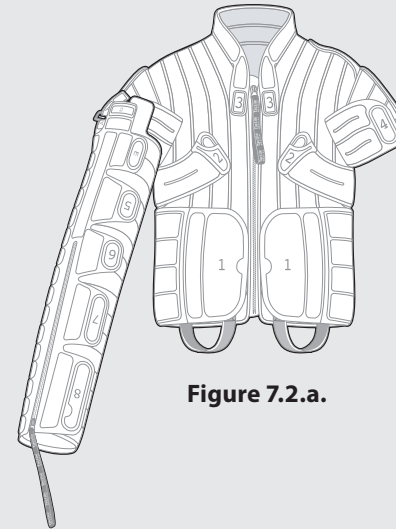


Figure 7.2.a.

**NOTE:** If you have been prescribed simultaneous bilateral treatment, you will need to prepare and attach both a left arm garment and a right arm garment to your vest garment (**Figure 7.2.b.**).

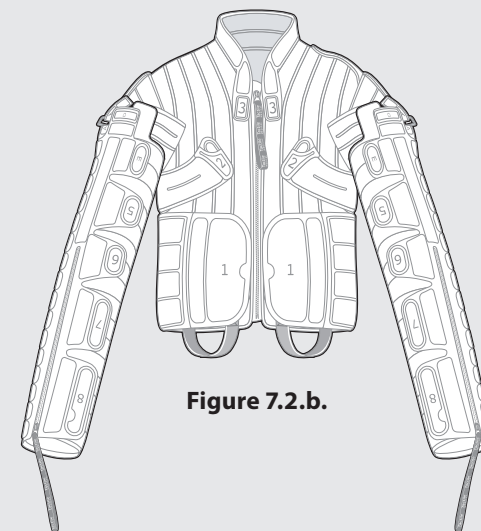


Figure 7.2.b.

## Preparing Your Vest and Arm Garment for the First Time

1. If you are not currently wearing your vest garment, locate it and slide it on as you would a jacket. Identify both ends of the front zipper, and zip closed your vest garment using the front zipper pull. Put your thumbs through the black handle loops at the front bottom of your vest garment, and push downward to adjust vest garment positioning (**Figure 7.2.c.**).

**NOTE:** Take a moment to identify the strap labeled 'A' located on each shoulder of your vest garment.

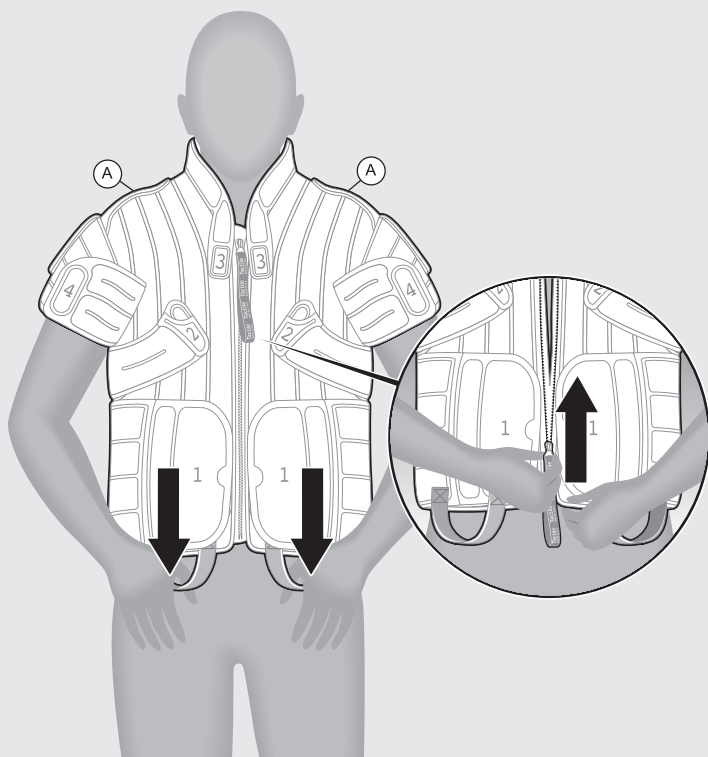
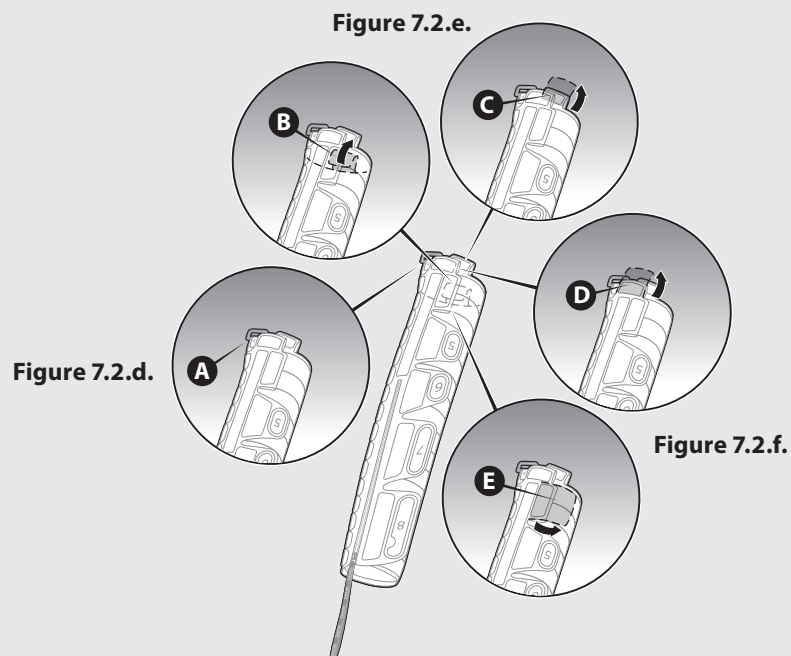


Figure 7.2.c.

2. Your arm garment should arrive in a formed loose "cylinder." Ensure all adjustment tabs are folded onto themselves to prevent accidental sticking as you prepare your arm garment.

**NOTE:** Take a moment to identify each of the following components:

- The adjustment tab labeled 'A,' connected to the D-ring on the wider end of your arm garment (**Figure 7.2.d.**).
- The adjustment tabs labeled 'B' and 'C,' located on the wider end of your arm garment (**Figure 7.2.e.**).
- The adjustment tabs labeled 'D' and 'E,' located on the top side of the wider end of your arm garment (**Figure 7.2.f.**).

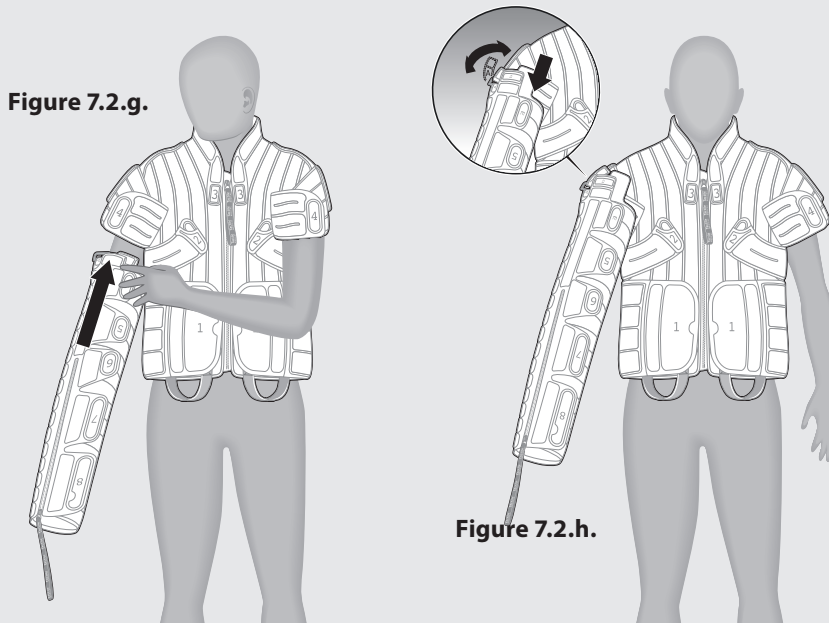


- Using your non-treatment arm, grab the inner fabric and D-ring together. Slide your arm that will be receiving treatment, into the garment, so the garment overlaps the biceps portion of your vest garment sleeve (**Figure 7.2.g.**). The D-ring should be visible on the top of the arm garment. Open strap 'A,' and thread the end of the strap through the D-ring in an upward motion. Ensure your fingertips remain covered. Fold over the Velcro® end of the strap to secure it (**Figure 7.2.h.**).

**NOTE:** To help with proper arm garment positioning, it is important to line-up the forearm zipper on your arm garment with your thumb on your arm that will be receiving treatment. This will allow your hand to become more easily accessible.

**NOTE:** If you are unable to thread the adjustment strap labeled 'A' through the D-Ring, you may use the alternative approach to preparing your arm garment. See pages 74–76 for further instructions.

**NOTE:** This step helps set the length and rotation of your arm garment when attached to your vest garment.

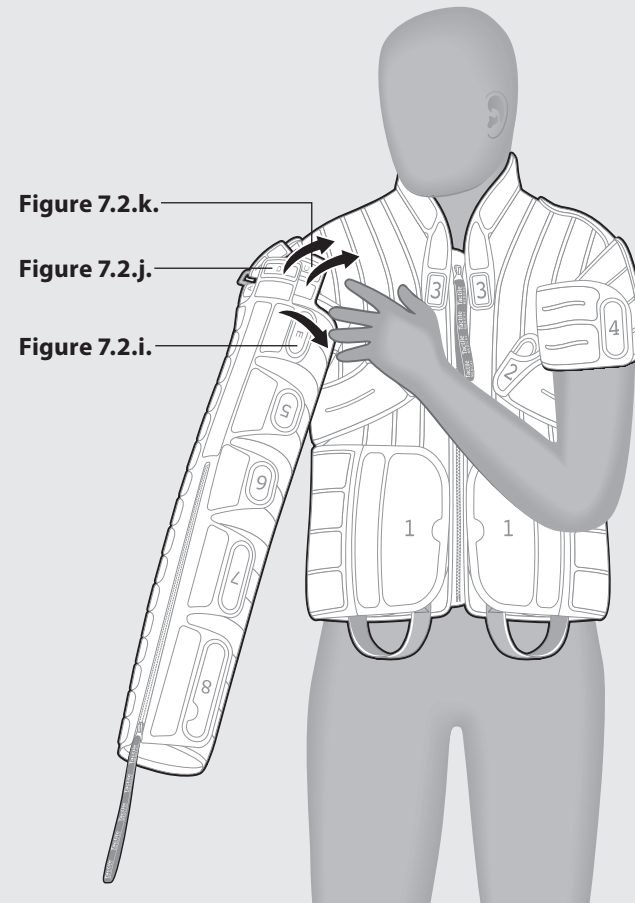


**NOTE:** Ensure your arm garment overlaps the biceps portion of your vest garment to minimize gapping. If overlapped correctly, there should be no gap between your vest garment and your arm garment.

- Locate the adjustment tab labeled 'E' at your armpit. Unfold adjustment tab 'E' and attach it snugly to conform the arm of your vest garment around your biceps. Smooth the inner fabric, if needed (**Figure 7.2.i.**).

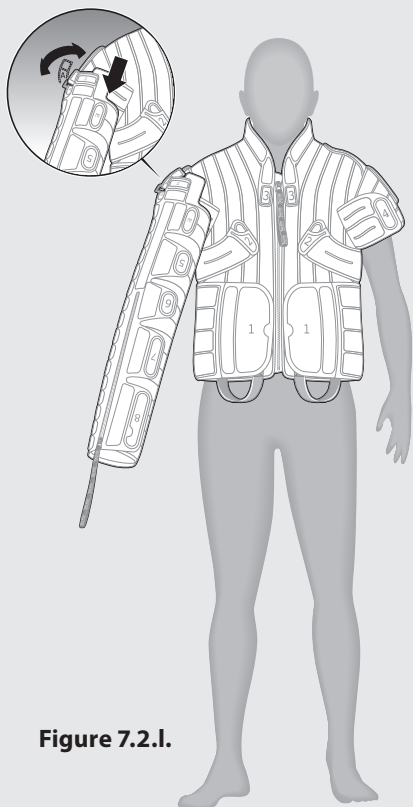
**NOTE:** A portion of the Velcro® may still be exposed.

- Locate the adjustment tab labeled 'D.' Unfold and attach it to the vest garment (**Figure 7.2.j.**).



6. Locate the adjustment tabs 'B' and 'C.' Unfold and attach them to the vest garment (**Figure 7.2.k.**).

**NOTE:** Now that all adjustment tabs are in place, they should remain in place unless minor adjustments are needed. If your arm garment needs to be shortened, detach the lettered tabs, and tighten the 'A' strap to bring the arm garment 1"–2" higher up on the sleeve of your vest garment (**Figure 7.2.l.**).

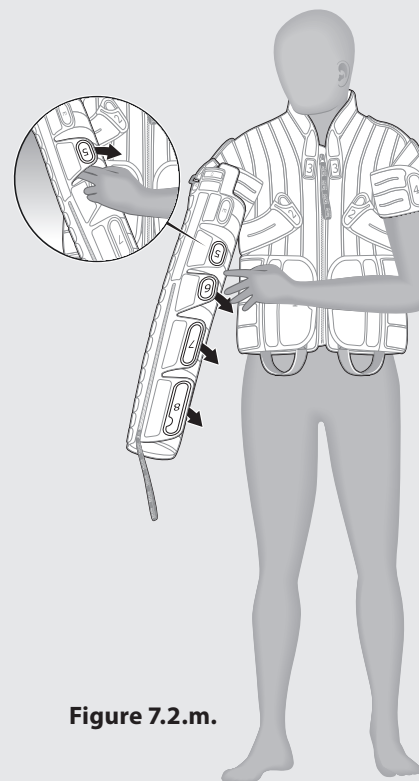


**Figure 7.2.l.**

7. To finalize the fitting of your arm garment, unhook the adjustment tab labeled '5' and pull inward toward your body until you feel a snug – but not tight – fit. Attach adjustment tab '5' to your arm garment. Once attached, you should be able to slide two fingers under adjustment tab '5.'

Repeat for the adjustment tabs labeled '6' through '8,' moving down your arm garment toward your hand and smoothing out the inner fabric between each adjustment tab placement. Your fingertips should remain fully enclosed within your arm garment (**Figure 7.2.m.**).

**NOTE:** To adjust your arm garment, ensure your clothing underneath your arm garment is not bunched up; adjust/pull down your clothing, as necessary.



**Figure 7.2.m.**

**NOTE:** Your arm garment should not feel as tight as a compression garment.

**NOTE:** If your fingers stick out the end of your arm garment, you can lengthen your arm garment by adjusting the 'A' strap and the **lettered** adjustment tabs during arm garment attachment (**Figure 7.2.n.**).

**NOTE:** Follow the above steps to properly attach your second arm garment if you have been prescribed simultaneous bilateral treatment. For help connecting both of your arm garments to the controller unit, refer to the video, "Connecting Your Garments to the Controller Unit," located at <https://tactilemedical.com/training/#video-connecting-garments-to-the-controller-unit>

You are now ready to begin your treatment session. See Chapter 9 for further instructions.

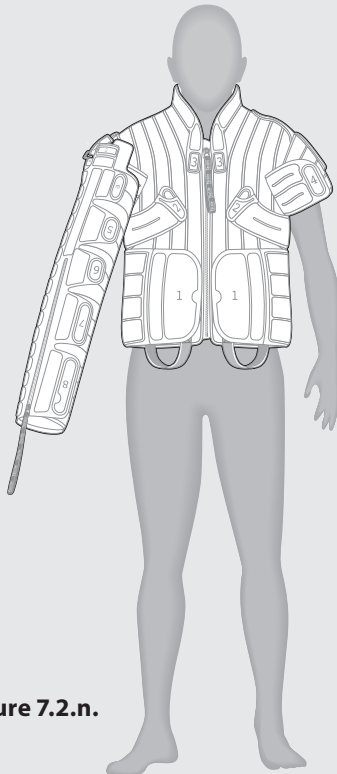


Figure 7.2.n.

### Alternative Option for Preparing Your Vest and Arm Garment for the First Time

1. Unfold and place your arm garment on a bed or sofa with the zipper closed. Ensure all adjustment tabs are folded onto themselves to prevent accidental sticking as you prepare your arm garment (**Figure 7.2.o.**).
2. Grab the plastic D-ring and inner fabric to expose the inside of your arm garment. Next, grab the biceps portion of your vest garment, and insert it into your arm garment.
3. Locate strap 'A' on your vest garment and thread it downward through the plastic D-ring on your arm garment. After inserting it into the plastic D-ring, fold over strap 'A' to close. Ensure strap 'A' lays flat once threaded through the plastic D-ring (**Figure 7.2.o.**).

**NOTE:** This adjustment sets your arm garment length and orientation.

4. Next, locate the adjustment tabs labeled 'D,' 'C' and 'B.' Unfold these tabs, and attach them to your vest garment (**Figure 7.2.o.**).

**NOTE:** You may need to flip over your combined vest and arm garment to locate the tabs labeled 'B' and 'C.'

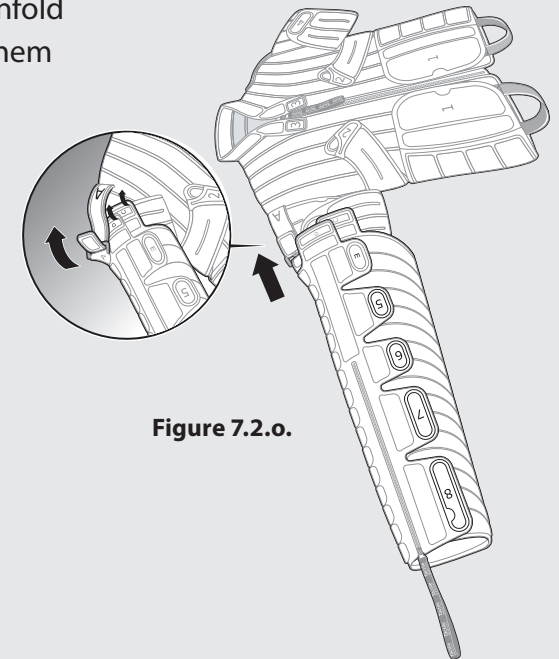


Figure 7.2.o.



5. Unzip your forearm zipper, so your hand can remain free once you put on your combined vest and arm garment.
6. Slide your vest garment on as you would a jacket, starting with the affected arm. Identify both ends of the front zipper, and zip your vest garment closed using the front zipper pull. Put your thumbs through the black handle loops at the front bottom of your vest garment, and push downward to adjust vest garment positioning (**Figure 7.2.p.**).

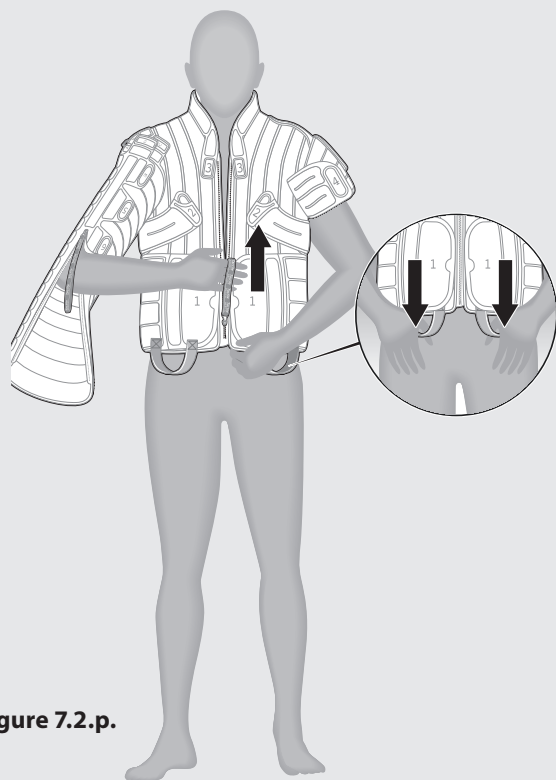


Figure 7.2.p.

7. Zip your arm garment closed (**Figure 7.2.q.**).
8. Locate the tab labeled 'E' at your armpit, and unfold and attach it to snugly conform your arm garment around your biceps. Smooth the inner layer of fabric, if needed (**Figure 7.2.q.**).

**NOTE:** To contour your arm garment, ensure your shirt underneath your arm garment is not bunched up; pull it down, if necessary.

9. Unhook the tab labeled '5' from your arm garment, and pull inward until you achieve a snug – but not tight – fit. Check to see if you can slide two fingers under tab '5' when attached. Repeat for the tabs labeled '6,' '7,' and '8,' moving down your arm garment toward your hand and smoothing out the inner fabric between each tab adjustment. Your fingertips should remain fully enclosed within your arm garment (**Figure 7.2.q.**).

**NOTE:** Your arm garment should not feel as tight as a compression sleeve.

**You are now ready to begin your treatment session. See Chapter 9 for further instructions.**

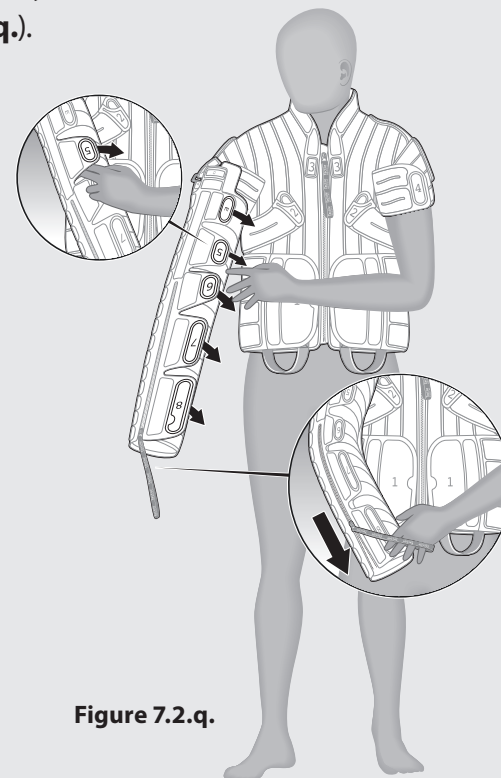


Figure 7.2.q.



## Optional Hand Loop Application for Your Arm Garment

If you feel you need additional support when fitting your arm garment, an additional hand loop can be attached to the inside of your arm garment. The following steps will help you attach the hand loop to your arm garment (**Figure 7.2.r**):

- Unzip the forearm zipper on your arm garment.
- Check to see where your natural hand location falls within your arm garment.
- Attach the handle closest to your body to the outer layer of fabric between your thumb and index finger.
- Attach the handle that is farthest from your body to the inside of your arm garment, while making sure it crosses over your hand.
- To continue fitting your arm garment, grab the hand loop with your hand, and flatten your hand while holding onto the hand loop.

**NOTE:** The hand loop is optional and can be requested by contacting Tactile Medical using one of the following options.

- **Text or Call:** 612.355.5100
- **Toll Free Phone:** 833.3TACTILE (833.382.2845)
- **Email:** [customerservice@tactilemedical.com](mailto:customerservice@tactilemedical.com)
- **Customer Care Hours:** 7 a.m. to 7 p.m. CT, Monday–Friday

If you decide you do not require the use of the hand loop, you may remove it from your arm garment with the following steps (**Figure 7.2.s**):

- Unzip your arm garment.
- Remove the hand loop by detaching the Velcro® on both handles.
- Use the forearm zipper to zip your arm garment closed, and make minor adjustments to the adjustment tabs labeled '5' through '8,' as necessary.

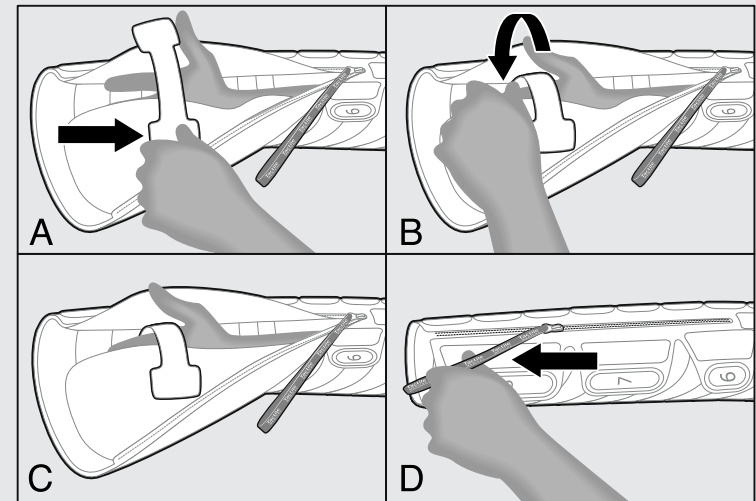


Figure 7.2.r.

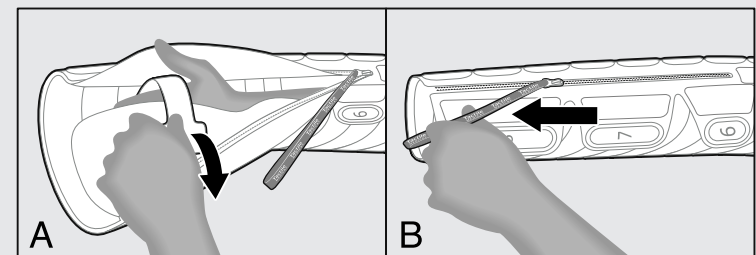
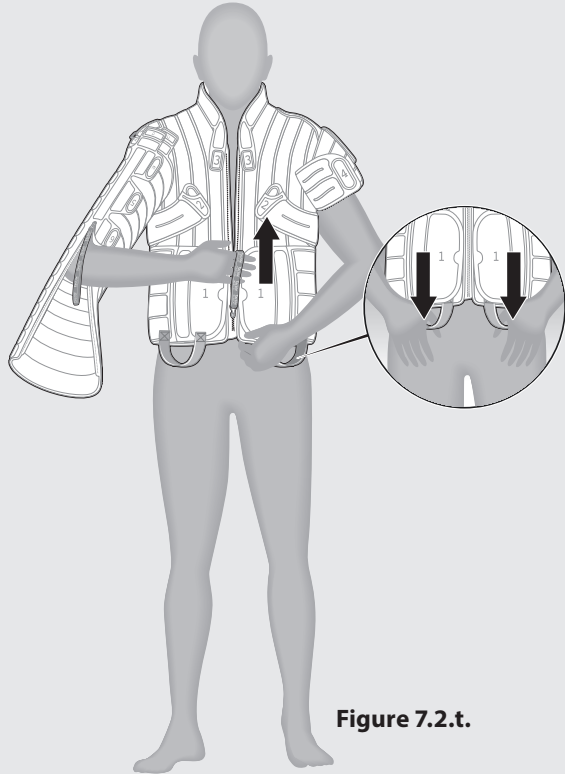


Figure 7.2.s.

## Applying Your Vest Garment and Arm Garment for Daily Treatment

**NOTE:** If your treatment requires a trunk garment, see **Chapter 5, Section 5.1.**

- Slide your vest garment on as you would a jacket by inserting your arm into your formed arm garment (**Figure 7.2.t.**). Push back the fabric around the forearm zipper to free-up your covered hand. Use the zipper lanyard to zip your vest garment closed. Put your thumbs through the black handle loops at the bottom of your vest garment on each side of the zipper, and push downward to adjust the position of the vest garment.

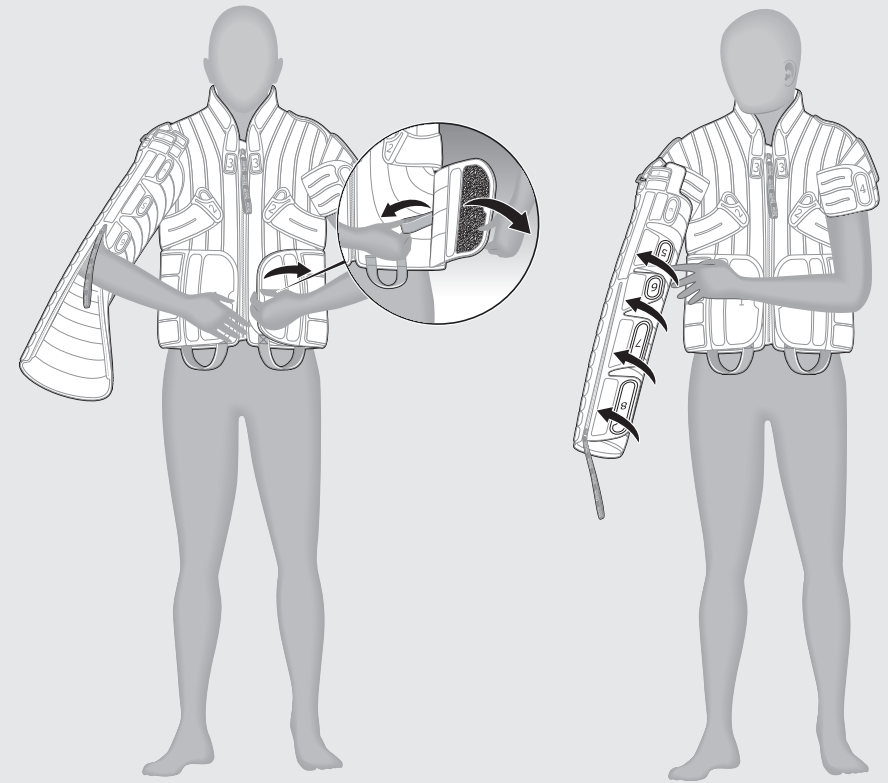


**Figure 7.2.t.**

**NOTE:** If your vest garment is too tight, you may need to readjust the black cinch straps slightly at your abdomen, or use the tabs labeled '1' through '4' (**Figure 7.2.u.**).

**NOTE:** If your arm garment is too tight, you may need to readjust the tabs labeled '5' through '8' slightly (**Figure 7.2.v.**).

**You are now ready to begin your treatment session. See Chapter 9 for further instructions.**



**Figure 7.2.u.**

**Figure 7.2.v.**

## Removing Your Vest and Arm Garment

9. To remove your vest and arm garment at the end of your single-arm treatment session, unzip your forearm zipper. Turn your controller unit off, and disconnect your vest and arm garment.

Remove your vest and arm garment by unzipping the front zipper pull. Locate the black handle loops at the front bottom of your vest garment. Using your thumbs in the handle loops, push downward while rolling your shoulders outward to remove your vest and arm garment like a jacket (**Figure 7.2.w.**).

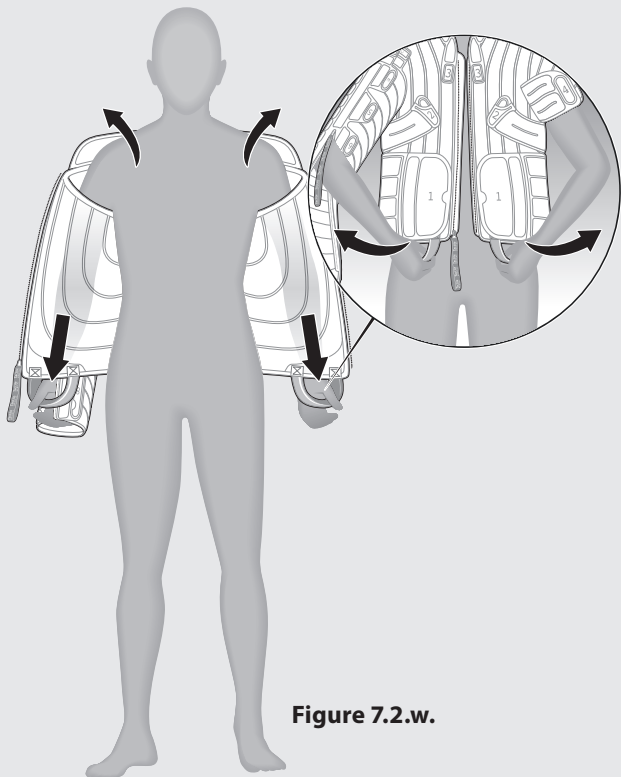


Figure 7.2.w.

**NOTE:** You should remove your vest and arm garment first, followed by your trunk garment (if you are prescribed the use of a trunk garment).

**NOTE:** If your vest and arm garment feels tight and is difficult to remove, loosen the adjustment tabs labeled '3' (**Figure 7.2.x.**). You also may use the "weight" of the vest and arm garment on the treatment side to help slide the garment off (**Figure 7.2.y.**).

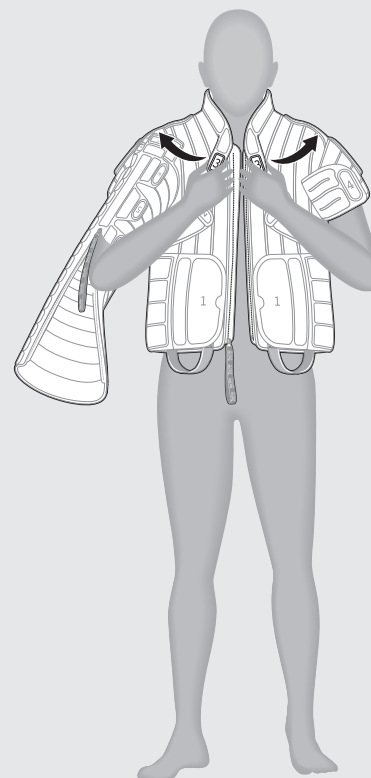


Figure 7.2.x.

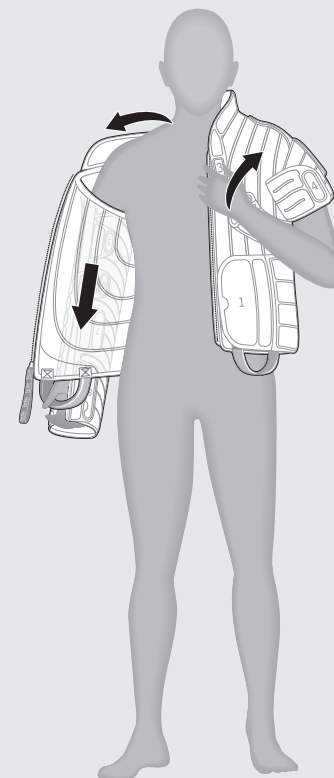


Figure 7.2.y.

## 7.3 Applying Your Flexitouch Plus Arm-Shoulder Garment

### Preparing Your Arm-Shoulder Garment for the First Time

1. In preparation for donning the arm-shoulder garment, loosely form the arm portion of your garment into a cone shape, and fasten the hook tabs.

**NOTE:** Adjust the tabs around the biceps section, so you will be able to slide your affected arm into the garment easily.

2. Unfasten the chest strap on the front of your garment, so you are able to apply the garment.

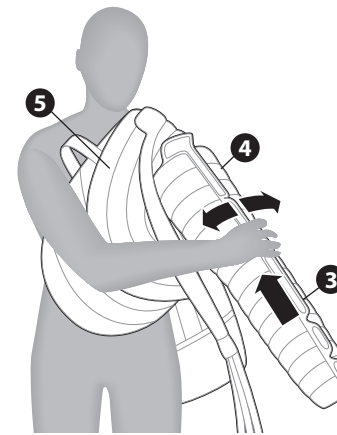
### Arm-Shoulder Application:

3. Slide your arm into the pre-shaped cone, making sure the tabs run along the front of your garment (#3 in **Figure 7.3.a.**).

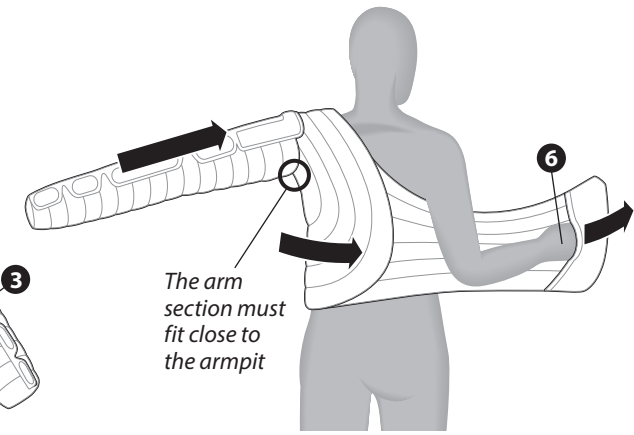
**NOTE:** Pay particular attention to fitting the contours of the wrist and elbow areas snugly.

4. Pull the arm portion of the garment up toward your shoulder (#4 in **Figure 7.3.a.**), making sure your fingertips remain fully enclosed in the garment.
5. Ensure the chest flap attached to the arm piece crosses the center line of your chest and is flat against your chest (#5 in **Figure 7.3.a.**).
6. Place your free hand (extremity not being treated) in the pocket located at the end of the chest strap (#6 in **Figure 7.3.b.**), and wrap it around the front of your chest.
7. Readjust and tighten the hook fasteners on the biceps, under the arm and on the arm to obtain a well-contoured fit (#7 in **Figure 7.3.c.**).

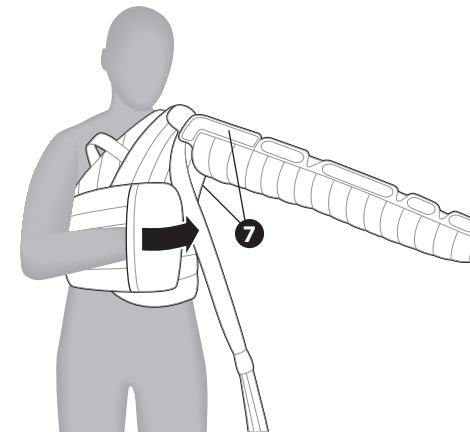
8. Properly applied, your garment and accessories will follow the contours of your body and fit snugly, yet comfortably (**Figure 7.3.d.**). Make any necessary adjustments after you lie down to ensure a well-contoured fit.



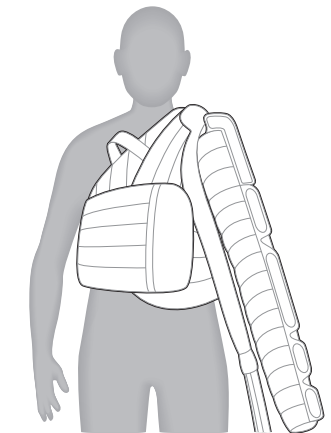
**Figure 7.3.a.**  
Preparing the Garment



**Figure 7.3.b.** Applying the  
Arm-Shoulder Garment



**Figure 7.3.c.**  
Ensure a Well-Contoured Fit

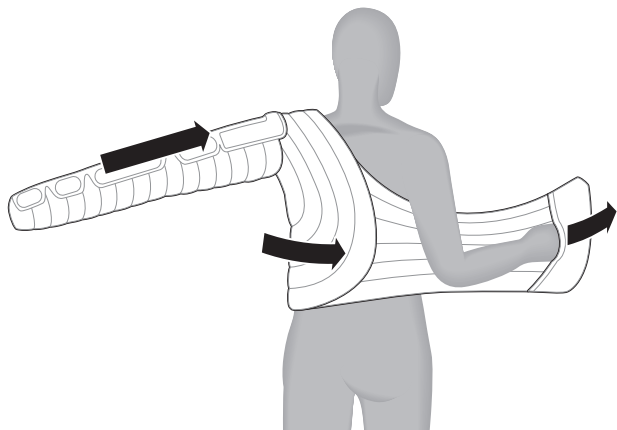


**Figure 7.3.d.** Fully Applied  
Arm-Shoulder Garment

## Applying Your Arm-Shoulder Garment for Daily Use

**NOTE:** If your treatment requires trunk garment, see **Chapter 5, Section 5.1.**

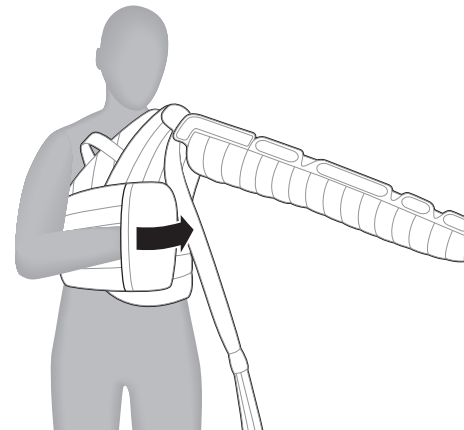
9. Locate your arm-shoulder garment and undo the chest strap on the front of the garment and slide it on like a jacket. Pull up on the shoulder area so it is close to the neck and lies flat along the top of the shoulder (**Figure 7.3.e.**). Make sure your fingertips remain fully enclosed at the end of the garment.



**Figure 7.3.e.**

**NOTE:** Ensure the inner and outer chest flaps cross the center of your body and contour to the chest area. It may help to gently pull the tubing down to secure the garment in place.

10. Place your free hand in the pocket located at the end of the chest strap. Wrap it around the front of your body and secure it to the outer chest flap (**Figure 7.3.f.**).

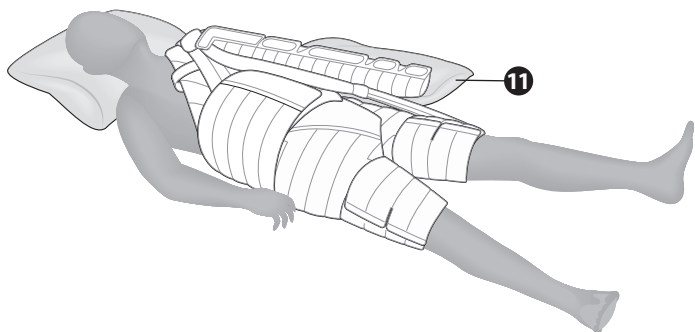


**Figure 7.3.f.**

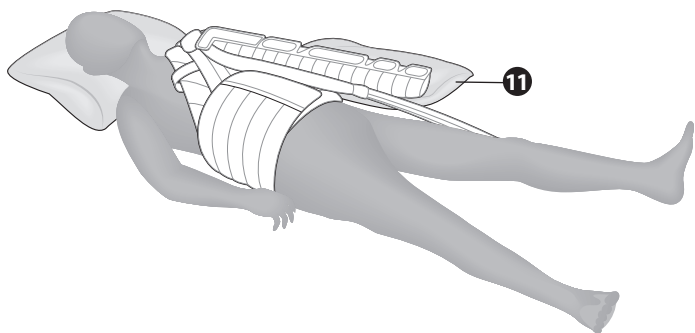
**NOTE:** Make any necessary adjustments after you lie down to ensure a well-contoured fit.

11. Use a pillow to elevate your arm slightly above your torso during treatment (#11 in **Figures 7.3.g.** and **7.3.h.**), and angle your arm about 45 degrees out from the side of your body.

**NOTE:** If your treatment requires the use of a trunk garment, see **Chapter 5, Section 5.2.**



**Figure 7.3.g. Fully Applied Trunk and Arm-Shoulder Garment**

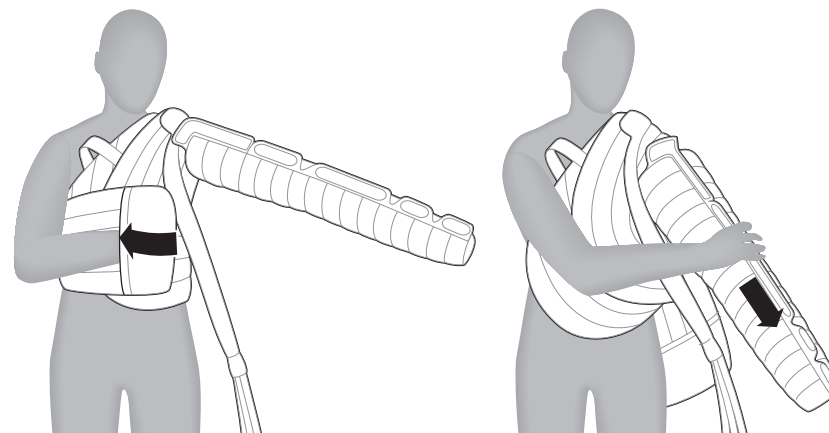


**Figure 7.3.h. Fully Applied Arm-Shoulder Garment**

**You are now ready to begin your treatment session. See Chapter 9 for further instructions.**

## **Removing Your Arm-Shoulder Garment**

12. To remove your garments at the end of the treatment session, you should remove the arm-shoulder garment first, followed by the trunk accessory. Turn your controller unit off, and disconnect your arm-shoulder garment.
13. Remove the arm-shoulder garment by placing your hand in the pocket of the chest strap, and open it to remove the garment. The garment should slide on and off like a jacket (**Figure 7.3.i.**).



**Figure 7.3.i.**



## Head and Neck Garment Application

Complete the following steps prior to starting treatment.

1. Make sure you are using the recommended garments and accessories to complete your treatment.
2. Choose a treatment time with limited interruptions to avoid pausing treatment. The treatment session typically lasts 12–32 minutes.
3. Determine the type of garment you have:
  - Flexitouch Plus with ComfortEase Vest Garment (see **Section 8.1**)
  - Flexitouch Plus with ComfortEase Head Garment (see **Section 8.2**)
  - Flexitouch Plus Vest Garment (see **Section 8.3**)
  - Flexitouch Plus Head Garment (see **Section 8.4**)

Refer to the label to determine which garment you have.

### CAUTION

To avoid skin irritation that may result from contact with the nylon material, wear lightweight, loose-fitting (non-elastic) cotton clothing (example: scrubs, stockinette); for head and neck garments, use a face mask or balaclava. If skin irritation develops, consult with your healthcare provider. It is recommended that you wear an undergarment to avoid potentially pinching skin with zipper.

Lymph fluid is moved through the vessels in the skin. It is important to avoid wearing anything during treatment that may hamper the lymph flow. These items include:

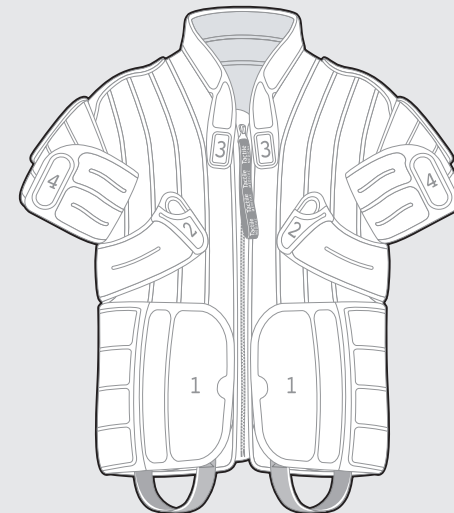
- **Belts**
- **Jewelry**
- **Restrictive clothing, such as:** elastic-banded underwear, compression bandaging, elastic-banded socks, compression garments or bra.

### CAUTION

- The Flexitouch Plus garments should not be placed in direct contact with an open wound. It is recommended that wounds be properly dressed before the garment is applied. Contact your healthcare provider if you have any questions.
- Consult your healthcare provider before using Flexitouch Plus garments that cover the chest (arm-shoulder garment, and vest for head and neck garment) if you have a tissue expander.
- Take care to avoid overheating when donning or doffing garments.
- Flexitouch Plus garments are designed to allow use by patients with tracheotomy tubes. Take care when donning or doffing garments to avoid disturbing tracheotomy tubes.
- Remove any hearing aids and/or eyeglasses before donning head and neck garments.

### 8.1 Applying Your Flexitouch Plus with ComfortEase Vest Garment

These instructions apply to the vest garment pictured in **Figure 8.1.a**.



**Figure 8.1.a.**

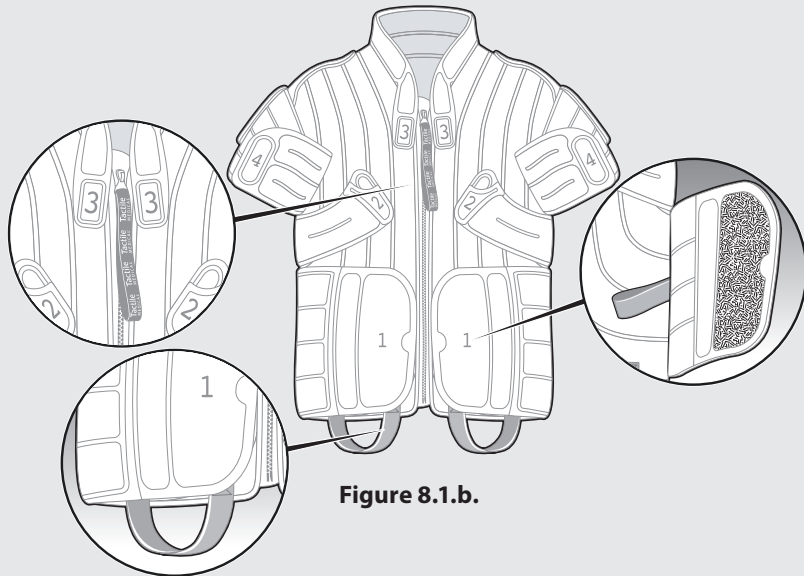
## Preparing Your Vest Garment for the First Time

1. Unfold and place your vest garment on a bed or sofa, so the zipper and the adjustment tabs labeled '1' through '4' are facing upward and the hose is visible.

**NOTE:** Take a moment to identify each of the following components:

- The adjustment tabs labeled '1,' located at the bottom of your vest garment.
- The adjustment tabs labeled '2,' located under each armpit.
- The adjustment tabs labeled '3,' located at the collar.
- The adjustment tabs labeled '4,' located at each biceps.

In addition, take a moment to locate the zipper lanyard on the front of your vest garment, the black cinch straps under the adjustment tabs labeled '1,' and the black handle loops at the bottom of your vest garment on each side of the zipper (**Figure 8.1.b.**)



**Figure 8.1.b.**

2. Slide your vest garment on as you would a jacket, and use the zipper lanyard to zip your vest garment closed (**Figure 8.1.c.**). Put your thumbs through the black handle loops at the front bottom of your vest garment, and push downward to adjust positioning.
3. Open the adjustment tabs labeled '1,' and attach each tab gently toward the rear of your vest garment – one on each side – so you are able to access the black cinch loops.

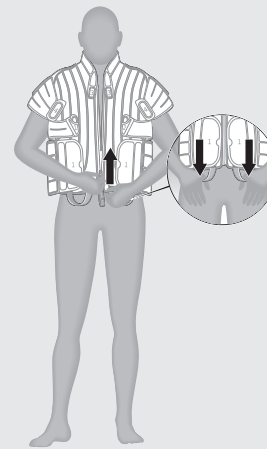
Detach both black cinch straps from your vest garment. Pull both straps forward at the same time toward the middle of your abdomen, without crossing your vest garment zipper, so that you feel a gentle – but not tight – contour at your lower back (**Figure 8.1.d.**)

4. Locate the adjustment tabs labeled '1,' and detach them from your vest garment. Pull both straps forward toward the front of your vest garment zipper, making sure not to overtighten the garment (**Figure 8.1.e.**)

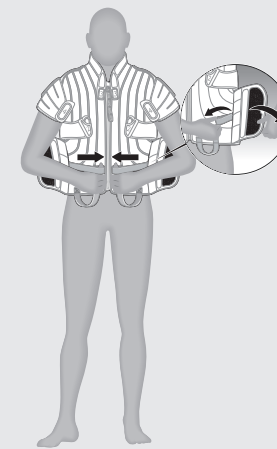
When applied, these tabs should overlay the black cinch straps.

**NOTE:** In some cases, the end of the black cinch straps may be visible.

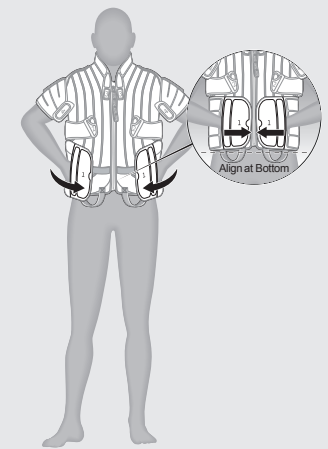
**NOTE:** Ensure the bottom of the adjustment tabs labeled '1' do not extend below your vest garment.



**Figure 8.1.c.**



**Figure 8.1.d.**

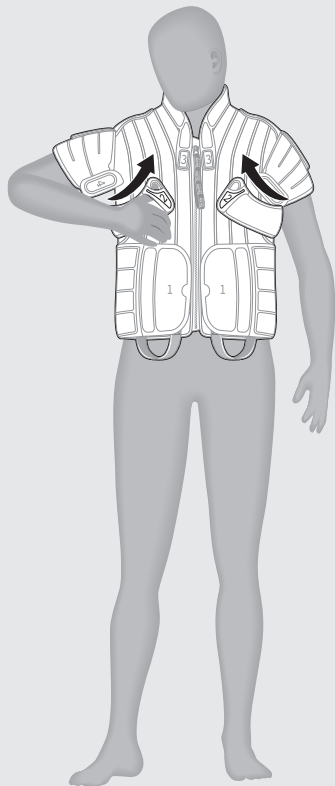


**Figure 8.1.e.**

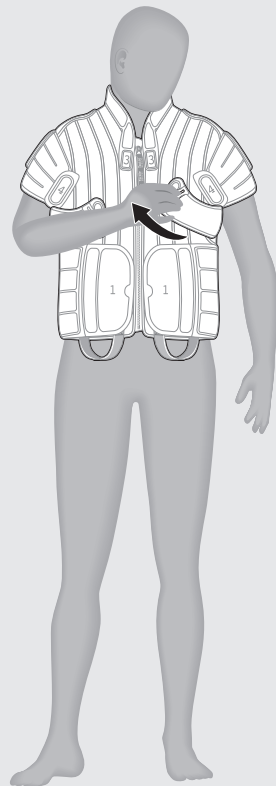
5. Locate the adjustment tabs labeled '2' under each armpit and place your thumbs through the end of the tabs. Pull the tabs forward and slightly upward, one at a time, to achieve a snug fit under each armpit (**Figure 8.1.f.**).

**NOTE:** If you're unable to grab the adjustment tab labeled '2' with your corresponding hand, reach across with your opposite hand and pull across and upward to ensure a snug fit under your armpits (**Figure 8.1.g.**).

**NOTE:** If you have not been prescribed head and neck treatment, you do not need to adjust the adjustment tabs labeled '3' at your collar.



**Figure 8.1.f.**

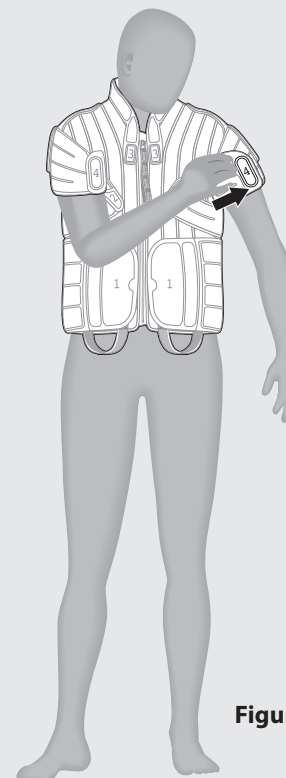


**Figure 7.1.g.**

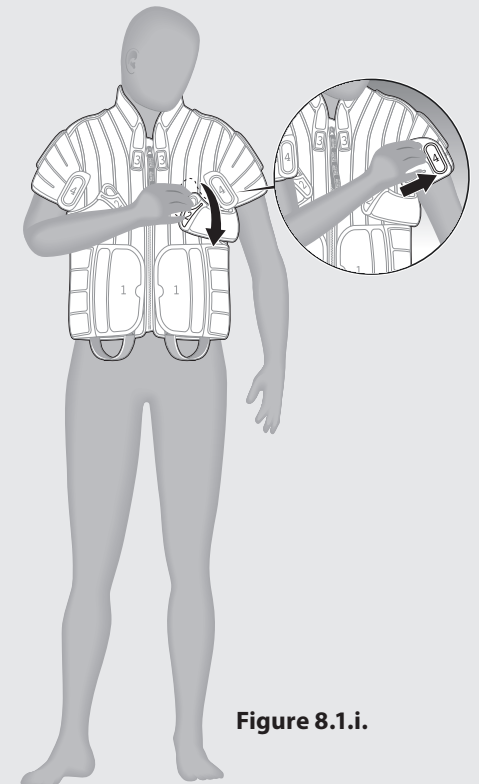
6. Locate the adjustment tabs labeled '4' on each arm. Detach each adjustment tab, one at a time, and smooth the inner flap downward and around the underside of your biceps. Reapply the adjustment tab labeled '4,' by pulling it forward and upward around the front side of your biceps to achieve a snug fit (**Figure 8.1.h.**).

**NOTE:** If it is difficult to reach the adjustment tab labeled '4' on either arm, you may temporarily loosen the adjustment tabs labeled '2' on your chest. Next, reapply the adjustment tabs labeled '4,' and then reapply the adjustment tabs labeled '2' (**Figure 8.1.i.**).

**NOTE:** If the adjustment tab labeled '4' becomes fully unwound and is not easy to reach, lean forward and the tab should be easier to grasp.



**Figure 8.1.h.**



**Figure 8.1.i.**

- If necessary, once all adjustment tabs have been applied, locate the black handle loops at the front bottom of your vest garment, and push in a downward motion to adjust the position of your vest garment on your upper body (**Figure 8.1.j**).

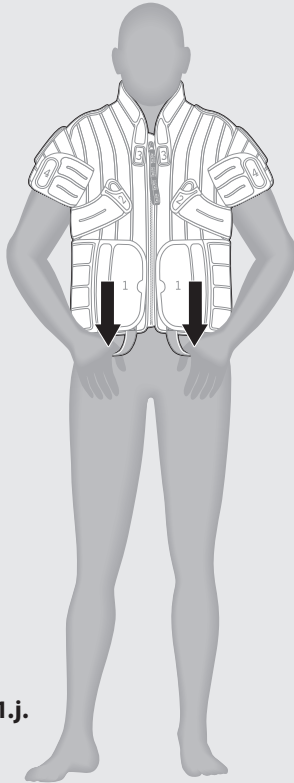


Figure 8.1.j.

### Applying Your Vest Garment for Daily Treatment

- Slide your vest garment on as you would a jacket. Zip your vest garment closed using the front zipper lanyard. Put your thumbs through the black handle loops at the bottom of your vest garment on each side of the zipper, and push downward to adjust positioning (**Figure 8.1.k**).

When properly applied, your vest garment will follow the contours of your body.

**NOTE:** If your vest garment is too tight, you may need to readjust the black cinch straps slightly at your abdomen, or use the adjustment tabs labeled '1' through '4.'

**You are now ready to begin your treatment session. See Chapter 9 for further instructions.**

### Removing Your Vest Garment

- To remove your vest garment, unzip the front zipper pull. Locate the black handle loops at the front bottom of your vest garment. Using your thumbs in the handle loops, push downward while rolling your shoulders outward to remove your vest garment like a jacket (**Figure 8.1.l**).

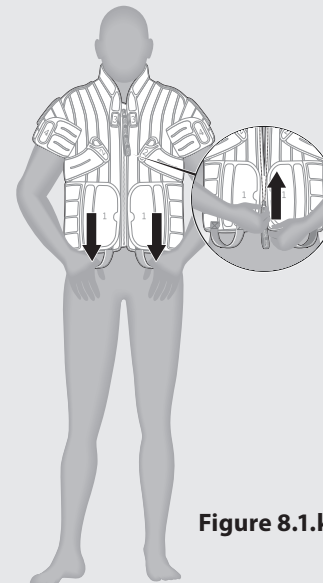


Figure 8.1.k.

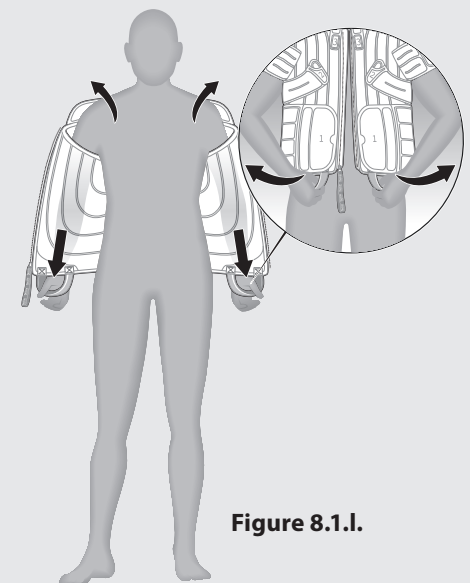
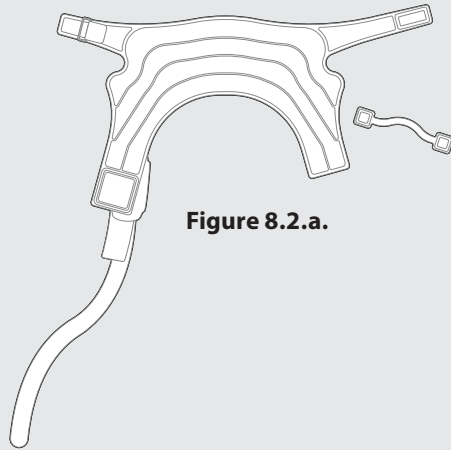


Figure 8.1.l.

## 8.2 Applying Your Flexitouch Plus with ComfortEase Head Garment

### Preparing Your Head Garment for the First Time

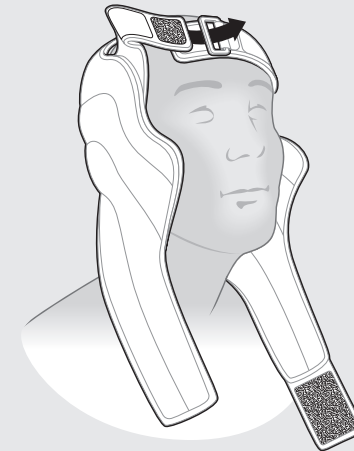
1. Unfold your head garment, so the head strap is facing up and located at the top. This is the front of the head garment. The nose piece is located with the garment. The chin straps are located at the bottom (**Figure 8.2.a.**).



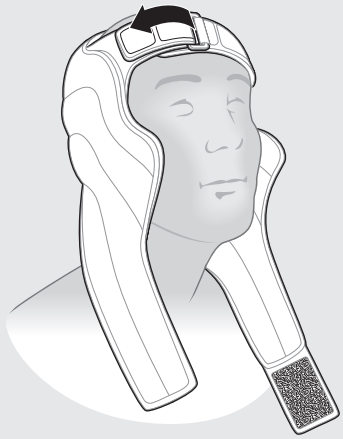
**Figure 8.2.a.**

**NOTE:** A mirror may be helpful for garment placement and fitting when applying the head garment.

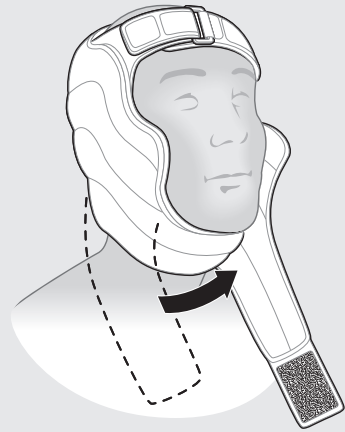
2. Place your head garment around the back of your head, aligning the top of the garment so the forehead strap runs across the crown of your head.
3. Pull the forehead strap through the plastic loop (**Figure 8.2.b.**). Tighten the garment by pulling on the forehead strap, and secure it by attaching the hook fastener of the forehead strap to the inner head strap (#3 in **Figure 8.2.c.**).
4. Adjust the right inner chin strap to fit snugly under your chin (**Figure 8.2.d.**).
5. Adjust the left outer chin strap over the top of the right inner chin strap, and fasten using the hook fastener (**Figure 8.2.e.**).
6. Conform the nose piece across the bridge of your nose, and attach the free hook fasteners to the side of your head garment to ensure good contact with your cheeks. Adjust your garment so it doesn't come into contact with your eyes (**Figure 8.2.f.**).



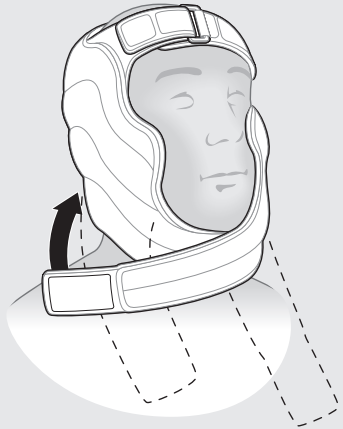
**Figure 8.2.b. Pull the Forehead Strap Through the Plastic Loop**



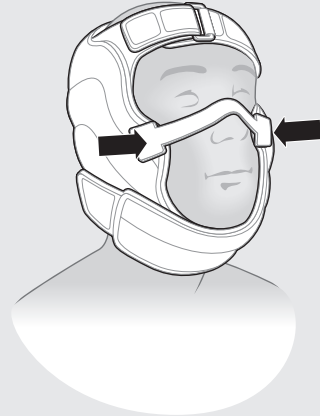
**Figure 8.2.c. Attach Hook Fastener to Inner Head Strap**



**Figure 8.2.d. Adjust Right Inner Flap Under Chin**



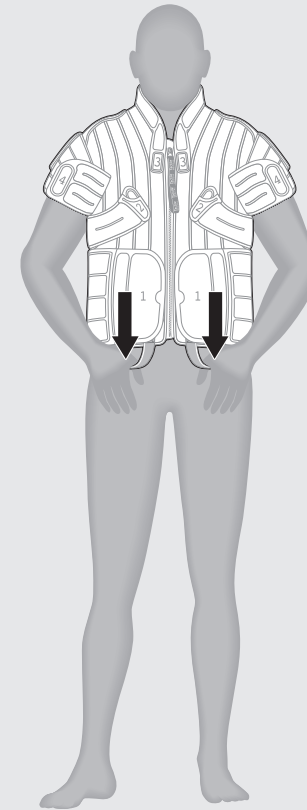
**Figure 8.2.e. Attach Hook Fasteners of Left Outer Chin Flap**



**Figure 8.2.f. Conform Nose Piece Across the Bridge of the Nose**

## Applying Your Head and Neck and Vest Garments for Daily Treatment

1. If you are not currently wearing your vest garment, locate it and slide it on as you would a jacket. Identify both ends of the front zipper, and zip your vest garment closed using the front zipper pull. Put your thumbs through the black handle loops at the front bottom of your vest garment, and push downward to adjust the position of your vest garment (**Figure 8.2.g.**).



**Figure 8.2.g.**



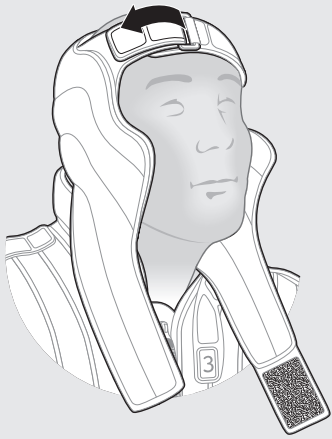


Figure 8.2.h.

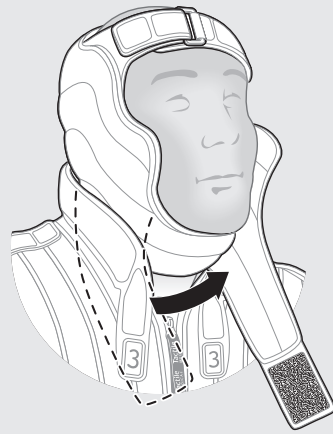


Figure 8.2.i.

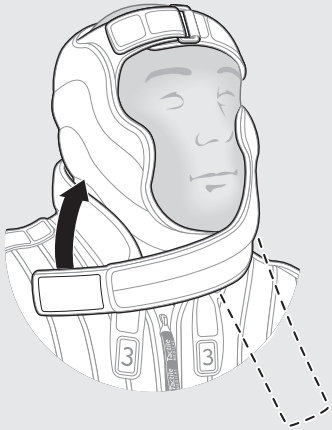


Figure 8.2.j.

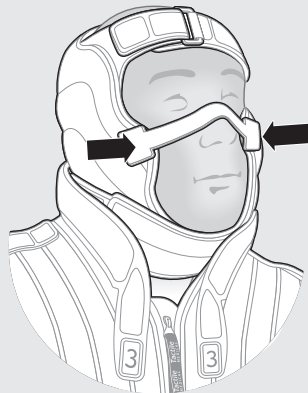


Figure 8.2.k.

2. Place your head and neck garment around your head, aligning the forehead strap so it runs across the middle of your forehead and fits snugly, but not too tight (**Figure 8.2.h.**).
3. Adjust the right inner chin strap, so it fits snugly under the chin (**Figure 8.2.i.**).
4. Secure the left outer chin strap over the right inner chin strap and fasten it using the hook fasteners. Adjust, as needed, to achieve a contoured fit around your chin (**Figure 8.2.j.**).
5. Conform the nose piece across the bridge of your nose, and attach the free hook fasteners to the side of your head garment to ensure good contact with the cheeks. Adjust your garment so it does not come into contact with your eyes (**Figure 8.2.k.**).
6. Locate the adjustment tabs labeled '3' on each side of the collar, and detach both '3' tabs from your vest garment. Pull downward at the same time to achieve a snug – but not tight – fit at the back of the neck (**Figure 8.2.l.**).

**NOTE:** When properly applied, your vest garment and head and neck garment will follow the contours of your body.

**You are now ready to begin your treatment session. See Chapter 9 for further instructions.**

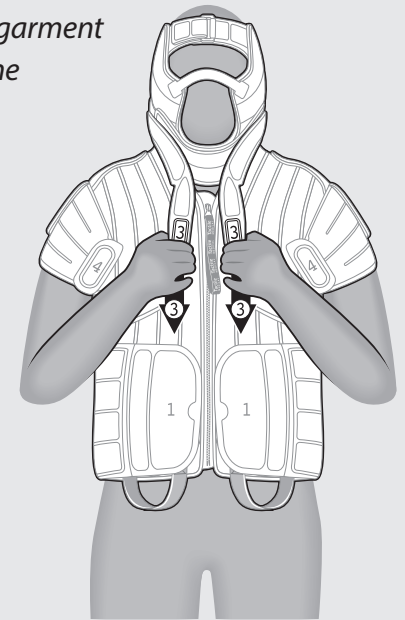


Figure 8.2.l.

## Removing Your Head and Neck and Vest Garments

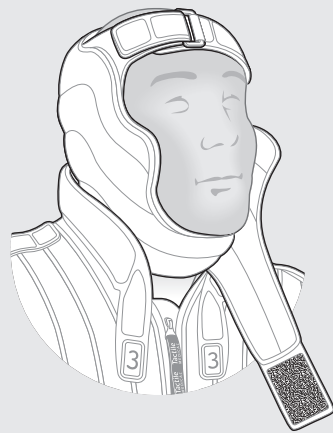
1. To remove your head and neck and vest garments, turn the controller unit off and disconnect your head and vest garment hoses from the controller unit.
2. Remove the nose piece, and attach it to the side of your head and neck garment (**Figure 8.2.m.**).

**NOTE:** Attaching your nose piece to the side of your head and neck garment reduces the chances of losing it.

3. Unfasten the chin straps (**Figure 8.2.n.**).

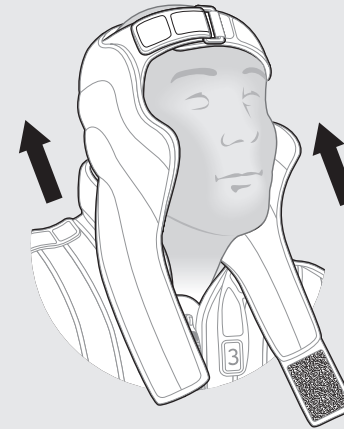


**Figure 8.2.m.**



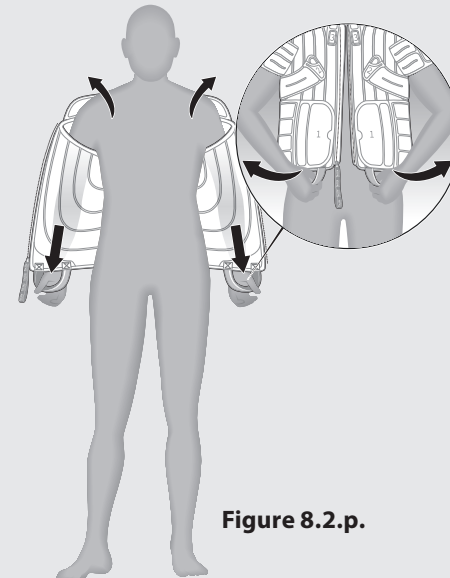
**Figure 8.2.n.**

4. Slide your head and neck garment off the top of your head, leaving the forehead strap fastened for your next use (**Figure 8.2.o.**).



**Figure 8.2.o.**

5. Remove your vest garment by unzipping the front zipper pull. Locate the black handle loops at the front, bottom of your vest garment, and push downward while rolling your shoulders outward to remove your vest garment like a jacket (**Figure 8.2.p.**).

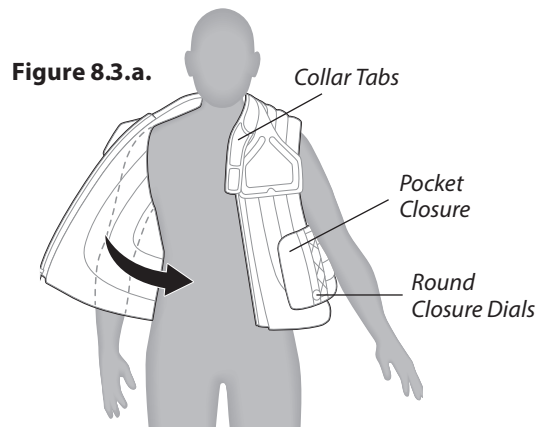


**Figure 8.2.p.**

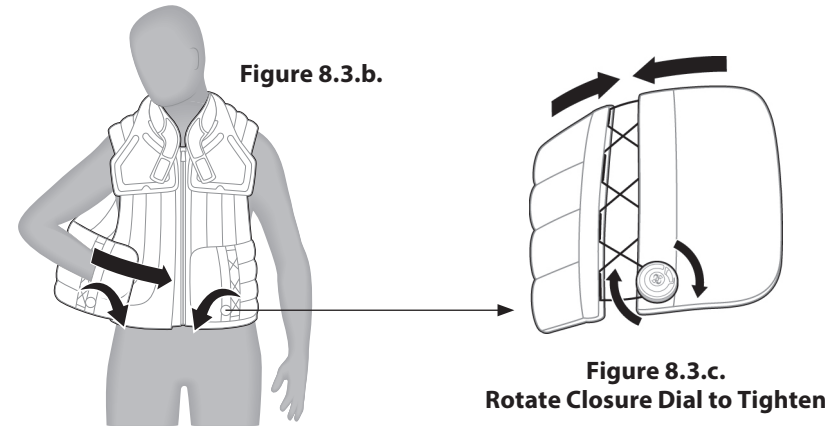
## 8.3 Applying Your Flexitouch Plus Vest Garment

### Preparing Your Vest Garment for the First Time

1. Unfold your vest garment so the zipper is facing up. This is the front of the vest garment. The collar tabs are located near the neck of the garment. The pocket and round closure dials are located on the abdomen (**Figure 8.3.a.**).
2. Attach the back straps to the back flap of the vest garment so it is shaped like a vest.
3. Slide your arms through the arm holes of the vest garment as you would a jacket (**Figure 8.3.a.**).
4. Align both sides of the front zipper at the bottom of the vest garment and zip up the front of the garment to the collar opening.

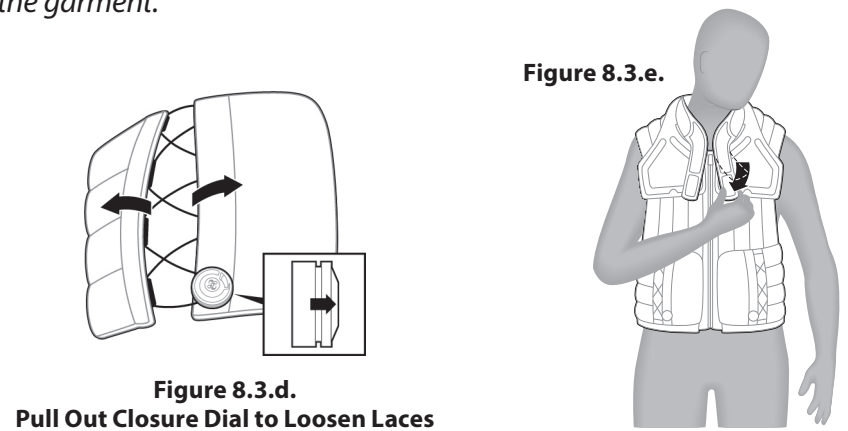


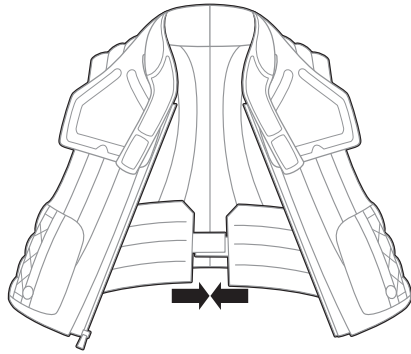
5. To adjust the fit of the vest garment around the waist, place your hands inside the pockets of the waist flaps and adjust the placement of the hook fastener pads on each side of the waist to achieve a snug fit (**Figure 8.3.b.**). To allow for easy garment removal, do not pull the waist flaps across the zipper in the front of the garment.
6. To tighten the vest garment around the waist, rotate the round closure dials on the waist flaps of the garment (**Figure 8.1.c.**).



7. To loosen your vest garment around the waist, pull out on the round closure dials located on both sides of the garment. Extend the closure laces by pulling the back of the garment away from the hook fastener pads on the front of the garment. Push the closure dials in until you hear a “click” to secure them (**Figure 8.3.d.**).
8. Pull the vest collar tabs straight down and attach the hook fastener pads to the chest of the vest garment (**Figure 8.3.e.**). The collar tabs should not cross over the zipper. They are designed to help the neck chamber of the garment maintain good contact with your neck during treatment.

**NOTE:** The collar tabs do not need to be readjusted at the start of each treatment session if you achieve a snug fit when initially contouring the garment.





**Figure 8.3.f.**

- To further fit the garment around the waist, remove the vest garment and adjust the placement of the hook fastener straps on the back panel of the vest. Move the hook fastener straps outward to make the vest larger or inward to make the garment smaller (**Figure 8.3.f.**).

**NOTE:** Properly applied garments will follow the contours of your body and fit snugly yet comfortably. To ensure they fit well, you may need to readjust the garment when you sit and recline.

- Sit in a soft-backed chair or recline at up to an angle up to 45 degrees.

**You are now ready to begin your treatment session. See Chapter 9 for further instructions.**

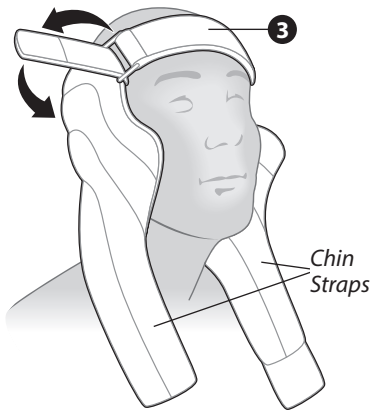
## 8.4 Applying Your Flexitouch Plus Head Garment

### Preparing Your Head Garment for the First Time

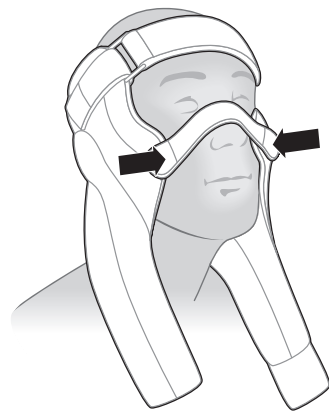
- Unfold your head garment, so the head strap is facing up and located at the top. This is the front of the head garment. The nose piece is located with the garment. The chin straps are located at the bottom by the chin (**Figure 8.4.a.**).

**NOTE:** A mirror may be helpful for garment placement and fitting when applying the head garment.

- Place your head garment around the back of your head, aligning the top of the garment so the forehead strap runs across the crown of your head.
- Pull the forehead strap through the plastic loop. Tighten the garment further by pulling on the forehead strap, and secure it by attaching the hook fastener of the forehead strap to the inner head strap (#3 in **Figure 8.4.a.**).
- Conform the nose piece across the bridge of your nose, and attach the free hook fasteners to the side of your head garment to ensure good contact with the cheeks. Adjust your garment so it doesn't come into contact with your eyes (**Figure 8.4.b.**).
- Adjust the right inner chin strap to fit snugly under your chin (**Figure 8.4.c.**).
- Adjust the left outer chin strap over the top of the right inner chin strap, and fasten it using the hook fastener (**Figure 8.4.d.**).



**Figure 8.4.a. Attach Hook Fastener to Inner Head Strap**



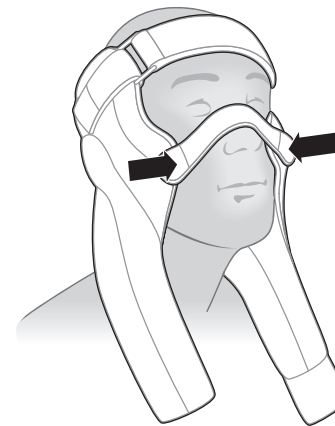
**Figure 8.4.b. Conform Nose Piece Across the Bridge of the Nose**



**Figure 8.4.c. Adjust Right Inner Chin Flap Under Chin**



**Figure 8.4.d. Attach Hook Fasteners of Left Outer Chin Flap**



**Figure 8.4.e.**



**Figure 8.4.f.**

### Applying Your Head and Neck Garment for Daily Use

7. Locate your head and neck garment, and slide the garment on so the plastic D-ring is positioned across the front of your forehead. Next, contour the nose piece across the bridge of the nose, and secure the hook fasteners to the side of the head garment. When contouring the nose piece, make sure the garment makes good contact with your skin but doesn't cause discomfort to your nose (**Figure 8.4.e.**).

**NOTE:** The head garment should never obstruct your vision or make contact with your eyes.

8. Lastly, find the chin straps located below the left and right cheeks. Adjust the right inner chin strap so it fits snugly under the chin. Then, secure the left outer chin strap over the right inner chin strap, and fasten using the hook fasteners. Adjust, as needed, to achieve a contoured fit around the chin (**Figure 8.4.f.**).

9. Locate your vest garment and slide it on as you would a jacket. Align both sides of the front zipper at the bottom of the vest garment, and zip up the front of the garment to the collar opening (**Figure 8.4.g.**). Sit in a soft-backed chair or recline at an angle up to 45 degrees.



**Figure 8.4.g.**

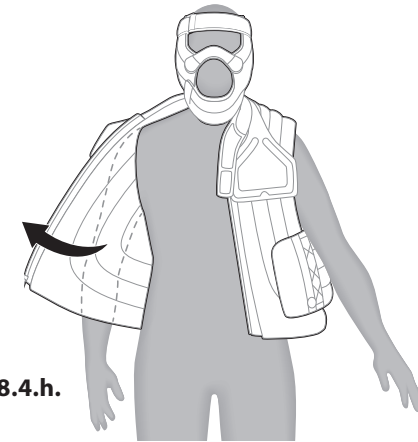
**NOTE:** Properly applied garments will follow the contours of your body and fit snugly yet comfortably. To ensure they fit well, you may need to readjust the garment when you sit and recline.

**You are now ready to begin your treatment session. See Chapter 9 for further instructions.**

**NOTE:** If your treatment requires trunk garment, see **Chapter 5, Section 5.1.**

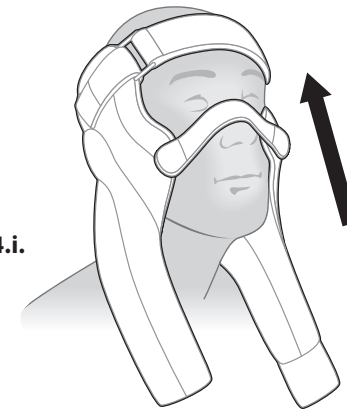
### Removing Your Arm-Shoulder Garment

10. To remove your garments at the end of the treatment session, remove the vest garment first and then the head garment (**Figure 8.4.h.**).



**Figure 8.4.h.**

11. Remove the vest garment by unzipping the vest and sliding your arms from the arm holes. To remove the head garment, start by unfastening the chin strap and nose piece, attaching the nose piece to the side of the garment so that it does not get lost. Slide the garment off the top of the head, leaving the forehead strap fastened for the next use (**Figure 8.4.i.**).



**Figure 8.4.i.**




## Conducting Your Treatment Session

Now you are ready for your treatment session with the Flexitouch Plus system. Be sure that you have followed the instructions outlined in the previous chapters. Then, begin the process of starting your treatment session using the instructions outlined below.





### CAUTION

To achieve maximum benefit, your session should be completed without interruption.

### 9.1 Starting Your Treatment Session

1. Prepare yourself for an uninterrupted treatment session.
- 2a: **If treating the upper or lower extremity(ies):** Lie down on your back with your hips and legs positioned straight. Do not sit in a chair or bend your affected limb(s) during the treatment session. Elevate the affected limb(s) on a pillow just above your hips.
- 2b: **If treating the head and neck:** Sit in a soft-backed chair or recline at an angle up to 45 degrees.
3. Check your program settings to ensure you have selected the correct program.
4. When properly positioned, press the  button on the controller unit to begin the highlighted treatment session (see **Figure 3.2.a.** on page 28 for an illustration of the controller unit front panel).
5. For best results, relax and take deep abdominal breaths during the treatment session.


### 9.2 Pausing Your Treatment Session

You may PAUSE TREATMENT for up to 15 minutes at any point during a treatment session by pressing the  button (see **Figure 3.2.a.** on page 28 for an illustration of the controller unit front panel). The controller unit will remain paused for up to 15 minutes. After that time, the controller unit will automatically shut off, requiring you to restart your treatment session. To resume your treatment, make sure the RESUME TREATMENT option is highlighted in blue and press the  button. To stop treatment, press the  arrow button to select STOP TREATMENT and press .

### 9.3 Completing Your Treatment Session

The treatment program will automatically stop when your treatment is completed.

### 9.4 Turning Your Controller Unit Off

When your treatment is complete, turn the controller unit off by pressing the  button located in the upper right corner of the controller unit, next to the screen (see **Figure 3.2.a.** on page 28 for an illustration of the controller unit front panel).

### 9.5 Storing Your Flexitouch Plus System

Store your Flexitouch Plus system using the following steps:

1. Unplug the power adapter from the controller unit and from the electrical outlet.
2. Store your garments and accessories by first coiling the harnesses for each of the supplied garments or accessories. Avoid kinking the tubing. It is preferable to store them by laying them flat. Do not stack anything on top of them.

3. Store the controller unit, garments and accessories in a cool, dry place. Keep them out of excessive heat or cold. Store them away from children and pets.

## 9.6 Cleaning the Flexitouch Plus System

### Cleaning the Controller Unit

The controller unit is to be cleaned, as needed, using a damp cloth and mild household cleaner.

1. Unplug the power adapter from the electrical outlet.
2. Wipe all accessible surfaces, including the power adapter.
3. After cleaning, allow the unit to dry completely prior to using.

### Cleaning the Garments and Accessories

4. A lint brush or roller may be used to remove particles.
5. The garments and accessories may be spot-cleaned using a damp cloth and a mild detergent.
6. Allow garments and accessories to dry thoroughly prior to using.

#### **WARNING: RISK OF ELECTRICAL SHOCK**

*Unplug the power adapter from the electrical outlet prior to cleaning the controller unit. Allow the controller unit to dry completely prior to connecting the power adapter to the electrical outlet.*

#### **CAUTION**

- Do not submerge
- Do not machine wash
- Do not disassemble
- Do not dry clean
- Do not machine dry
- Do not autoclave
- Do not iron

## Disinfecting the Flexitouch Plus System

DisCide® Ultra Spray Disinfectant has been demonstrated to effectively disinfect the Flexitouch Plus system. Use DisCide Ultra Spray or similar disinfectant compliant with OSHA's Bloodborne Pathogen Standard (29 CFR 1910.1030) and/or registered with the EPA. To disinfect the Flexitouch Plus system, including garments, controller unit or accessories between patient use, or if there are visible biological contaminants or visible stains, the following steps are recommended:

7. Clean any visible blood or body fluids from the surface of the garment.
8. Thoroughly wet surface with DisCide Ultra Spray Disinfectant.
9. Allow surfaces to remain wet for one minute and then allow to air dry.


#### **CAUTION**

*Follow instructions and warnings as issued by the manufacturer of any disinfecting product.*

# Troubleshooting and Specifications

If the information in Table 2 (below) does not help you solve the problem, please run a full treatment off your body, document what the controller screen states and contact Customer Care.

- **Text or Call:** 612.355.5100
- **Toll Free Phone:** 833.3TACTILE (833.382.2845)
- **Email:** customerservice@tactilemedical.com
- **Customer Care Hours:** 7 a.m. to 7 p.m. CT, Monday–Friday

 **CAUTION**  
*The Flexitouch Plus system contains no serviceable parts. Do not attempt to perform any unauthorized maintenance or repairs.*

## 10.1 Troubleshooting




Table 2: Troubleshooting	
Issue	Recommended Solution
Controller unit does not function or display does not illuminate	<ol style="list-style-type: none"> <li>1. Disconnect the power cord from the back of the controller unit and then reconnect it. Ensure that the power cord is fully inserted in both the power inlet on the back of the controller unit and the wall outlet.</li> <li>2. Press the  button.</li> <li>3. The display's backlight will illuminate the screen and display program options.</li> </ol>
The chambers do not fill with air (controller unit screen may read "The treatment failed with result R3, R4 or R5")	<ol style="list-style-type: none"> <li>1. Verify the correct program has been selected.</li> <li>2. Verify the connectors are attached to the correct controller unit connectors.</li> <li>3. Ensure both upper and lower connector latches are engaged.</li> <li>4. If the chambers still do not fill, turn the machine off, detach the connectors and turn the machine on again.</li> <li>5. Begin a treatment session.</li> </ol> <p><b>NOTE:</b> <i>If you feel air coming out of the connectors, reattach the connectors and check again.</i></p>

Table 2: Troubleshooting	
Issue	Recommended Solution
Hook fasteners do not stay closed	<p>With continued use, the outside of the fabric will become worn and the hook fasteners may become filled with debris.</p> <ol style="list-style-type: none"> <li>1. Clean debris from the hook fasteners using a stiff brush, such as a toothbrush or lint roller, or patting it with tape.</li> <li>2. If you continue to experience issues with the hook fasteners not adhering to the fabric, Tactile Medical can provide you with a replaceable garment pad that will cover the worn area of fabric and allow the hook fasteners to attach to an unworn surface. Text or Call Customer Care at 612.355.5100 or call toll free at 833.3TACTILE (833.382.2845) to request replaceable garment pads.</li> <li>3. To apply the replaceable pad when it is received, place the replaceable pad of fabric on the loop surface of the garment in the location where the hook fastener secures the garment.</li> <li>4. When applying the garment for treatment, secure the garment hook fastener to the new loop material on the replaceable pad.</li> </ol>
Chambers are not filling in the expected pattern	<ol style="list-style-type: none"> <li>1. Verify that the connectors have been attached to the controller unit, with both the top and bottom latches securely engaged.</li> <li>2. Verify that the connectors are attached to the correct controller unit connectors by checking corresponding numbers.</li> <li>3. Verify that the correct program has been selected.</li> </ol> <p><b>NOTE:</b> <i>The first half of many of the available programs have sections that do not inflate adjacent chambers sequentially.</i></p>
Chamber pressures are higher or lower than expected	<ol style="list-style-type: none"> <li>1. Verify the correct program, including correct pressure setting, has been selected.</li> <li>2. Adjust the fit of the garment, ensuring no folds or kinks are in the fabric.</li> <li>3. Check to be sure the latches are firmly in place and attached to the correctly numbered port.</li> </ol>
Chambers remain inflated	<p>It is normal for a small amount of air to remain in the chambers between inflations, giving the garment a puffy appearance. If the chambers remain fully inflated:</p> <ol style="list-style-type: none"> <li>1. Ensure that the tubing is not kinked or pinched.</li> <li>2. Disconnect the connectors and the chambers should deflate.</li> </ol>

Table 2: Troubleshooting	
Issue	Recommended Solution
Controller unit runs longer than expected	<p>The session length is controlled by the specific program selected and the number of treatment cycles chosen.</p> <ol style="list-style-type: none"> <li>1. Verify that the selected PROGRAM and TREATMENT CYCLES are as recommended by your healthcare provider.</li> <li>2. Upon completion of all treatment sessions, verify that the display indicates the treatment is completed.</li> <li>3. If the controller unit continues to operate beyond the time when COMPLETED is displayed, or if the TIME REMAINING indicated on the controller unit is incorrect, text or call Customer Care*.</li> </ol>
Latches have broken or become disconnected from garment connectors	<p>Latches can be replaced or reattached. Text or call Customer Care* for instructions.</p>
The controller unit makes an abnormal noise	<ol style="list-style-type: none"> <li>1. Stop the treatment session by pressing the  button.</li> <li>2. Verify the noise has stopped.</li> <li>3. Ensure the hoses from your garments are not kinked or pinched.</li> <li>4. Check the program selection and make sure the program you are running corresponds to the garments you are using. Make sure the selected garment size matches the garments used.</li> <li>5. Check to make sure the correct garment connectors are connected to the correct controller unit ports (<i>for example, the #4 garment connector is connected to the #4 port on the controller unit</i>).</li> <li>6. Restart the treatment by pressing the  button.</li> <li>7. If the noise continues, text or call Customer Care*.</li> </ol>

\* Tactile Medical Customer Care can be reached via text or phone at 612.355.5100, or toll free via phone at 833.3TACTILE (833.382.2845), 7 a.m. to 7 p.m. CT, Monday–Friday.


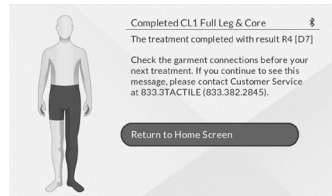
Table 2: Troubleshooting	
Issue	Recommended Solution
<p><b>The Controller unit reads: The treatment failed with result R3 (A6).</b> This means a specific garment chamber timed out 5 times in a row.</p> 	<ol style="list-style-type: none"> <li>1. Check the connection of all hoses to the controller unit to confirm any leaking air.</li> <li>2. If you discover leaking air, disconnect and reconnect the hose(s) to the controller unit.</li> <li>3. Try rerunning the program to see if the issue persists.</li> <li>4. If the issue persists, contact Customer Care via text or phone at 612.355.5100 or call toll free 833.3TACTILE (833.382.2845), 7 a.m. to 7 p.m. CT, Monday–Friday.</li> </ol>
<p><b>The Controller unit reads: The treatment failed with result R4 (A6).</b> This means 32 garment chambers timed out consecutively.</p> 	<ol style="list-style-type: none"> <li>1. Check that the bilateral port adapter is securely connected to the controller unit.</li> <li>2. Check the connection of all hoses to the controller unit to confirm any leaking air.</li> <li>3. If you discover leaking air, disconnect and reconnect the hose(s) to the controller unit.</li> <li>4. Try rerunning the program to see if the issue persists.</li> <li>5. If the issue persists, contact Customer Care via text or phone at 612.355.5100 or call toll free 833.3TACTILE (833.382.2845), 7 a.m. to 7 p.m. CT, Monday–Friday.</li> </ol>
An overpressure was detected in 3 consecutive chambers.	<ol style="list-style-type: none"> <li>1. Check that there are no kinks in any of the hoses as they run from your garment(s) to the controller unit. If you do find any kinking, disconnect the hose(s) from the controller unit, straighten out the hose(s), and reconnect to the controller unit.</li> <li>2. Ensure each hose is straightened out and nothing is blocking the connection with the controller unit.</li> <li>3. Once all hoses have been checked and reconnected, attempt treatment again.</li> <li>4. If the issue persists, contact Customer Care via text or phone at 612.355.5100 or call toll free 833.3TACTILE (833.382.2845), 7 a.m. to 7 p.m. CT, Monday–Friday.</li> </ol>

Table 2: Troubleshooting	
Issue	Recommended Solution
Unable to set up Bluetooth	Ensure your mobile device has Bluetooth turned on and has allowed Kylee access to Bluetooth data. If you are using an Android device, ensure you have granted Kylee access to location services. During the Bluetooth setup process, ensure your mobile device is within 10 feet of your plugged-in Flexitouch Plus device. Follow the instructions within Kylee to ensure your Flexitouch Plus device is in pairing mode.
Completed treatments are not appearing in Kylee	Complete the Bluetooth setup process. If you have already set up Bluetooth, make sure Bluetooth is enabled on your mobile device, and that you have the Kylee app open and within 10 feet of the plugged-in Flexitouch Plus device. Go to My Profile/My Device within Kylee to confirm the Flexitouch Plus sync status is green.
My Flexitouch Plus device is not connecting to Kylee	Ensure that Bluetooth is enabled on your mobile device, Kylee is open, and your mobile device is within 10 feet of your plugged-in Flexitouch Plus device. If the problem persists, remove the paired device in the Bluetooth Status menu of your Flexitouch Plus device, and attempt to re-pair your Flexitouch Plus device to Kylee.

## 10.2 Limited Warranty and Service for Home Use

Tactile Medical provides a warranty for the Flexitouch Plus system. The Flexitouch controller unit, garments and accessories are warranted to be free from defects in material and workmanship for a period of two (2) years from the date of shipment. Tactile Medical's sole obligation in the event of a breach of this warranty is expressly limited to the replacement of defective parts. Replacement parts may be new or refurbished parts as solely determined by Tactile Medical. No representation or other affirmation of fact set forth in this agreement, including but not limited to statements regarding suitability for use or performance of the Flexitouch Plus system, shall be deemed to be a warranty or representation by Tactile Medical for any purpose, nor give rise to any liability or obligation of Tactile Medical. EXCEPT FOR THE FOREGOING, TACTILE MEDICAL MAKES NO OTHER WARRANTY. THE WARRANTIES SET FORTH HERE ARE IN LIEU OF ALL OTHER WARRANTIES, EXPRESSED OR IMPLIED, WHICH ARE HEREBY DISCLAIMED AND EXCLUDED BY THE MANUFACTURER, INCLUDING WITHOUT LIMITATION ANY WARRANTY OF MERCHANTABILITY OR FITNESS FOR A PARTICULAR PURPOSE OR USE AND ALL OBLIGATIONS OR LIABILITIES ON THE PART OF TACTILE MEDICAL FOR DAMAGES ARISING OUT OF OR IN CONNECTION WITH THE USE, REPLACEMENT OR PERFORMANCE OF THE FLEXITOUCH PLUS SYSTEM. IN NO EVENT SHALL TACTILE MEDICAL BE LIABLE FOR ANY SPECIAL, DIRECT, INDIRECT OR CONSEQUENTIAL DAMAGES. Some states, provinces or countries do not allow exclusion or limitation of incidental or consequential damages, so the above limitation or exclusion may not apply. This warranty is available only to the original user if their account is in good standing. This warranty is not transferable. Alterations to the product not conducted by Tactile Medical shall void these warranties. These warranties do not cover failures due to improper or negligent use of the product. These warranties provide specific legal rights; there may be other available rights, which may vary by state, province or country.

If you have questions or to obtain warranty service, contact:

Tactile Medical  
Product Support Department

**Text or Call:** 612.355.5100

**Call Toll Free:** 833.3TACTILE (833.382.2845), 7 a.m. to 7 p.m. CT,  
Monday–Friday.

### 10.3 Limited Warranty and Service for Facility Use

Contact Tactile Medical for information regarding the service agreements available to facilities.

### 10.4 Equipment Lifetime

When used and maintained as instructed, the average expected controller unit lifetime is five (5) years.

### 10.5 Return Policy

Tactile Medical does not accept returns or provide refunds for any medical equipment dispensed to patients, including garments/sleeves, controller unit or any accessories once the original packaging has been opened. Unopened equipment may be returned within sixty (60) days of the date of shipment.

### 10.6 Patents

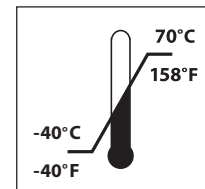
Patents pending.

## 10.7 Technical Information

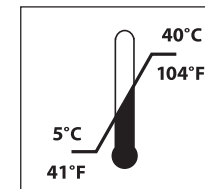
The Flexitouch Plus system has the following characteristics:

Table 3: Flexitouch Plus System—Technical Information	
Model Number	PD32–G3
Power Adapter Input	100–240 VAC 50/60 Hz
Device Input Voltage	12 VDC Nominal
Device Input Current	3.0 A Maximum
Current	1.0 A Maximum
Controller Unit Size	8”H x 10”W x 8”D (203 mm x 254 mm x 203 mm)
Controller Unit Weight	6.2 lbs. (2.8 kg)
Outer Fabric	100% nylon, not made with natural rubber latex
Treatment Programs	18
Chambers (max)	32
Mode of Operation	Continuous
Calibration	Recalibration not required for the Flexitouch Plus system
Electromagnetic Interference (EMI) Electromagnetic Compatibility (EMC)	The Flexitouch Plus system was designed to minimize the effects of external EMI upon the device and to minimize the effect upon the environment from the device. The device conforms to the appropriate EMC standards. See Table 5 on page 125.
Operating Atmospheric Pressure	700 to 1060 hPa

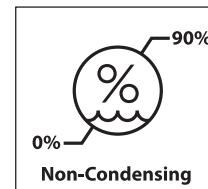
#### Device Transport and Storage Temperature Limits



#### Device Operating Temperature Limits



#### Device Transport and Storage Humidity Limits



#### Device Operating Humidity Limits

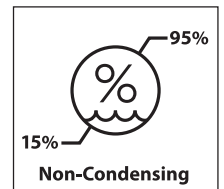




Table 4: Flexitouch Plus System—Classification Information	
U.S. FDA Medical Device	Class II per 21 CFR 870.5800 & 21 CFR 890.5650
Canada Medical Device	Class II per Canadian Medical Devices Regulations SOR/98-282
Protection Against Electric Shock Hazard	Class II per UL/EN/IEC 60601-1
Protection Against Fluid Ingress	IP21
Applied Part	BF

Table 5: Flexitouch Plus System—Conformance Information	
Quality Assurance	FDA 21 CFR 820 QSR ISO 13485
Safety	UL/EN/IEC 60601-1 CAN/CSA C22.2 No. 601.1
Electromagnetic Compatibility (EMC)	EN 60601-1-2
Waste Electrical & Electronic Equipment (WEEE)	Directive 2002/96/EC
Restriction of Hazardous Substances (RoHS)	Directive 2002/95/EC

## Wireless Technology

The Flexitouch Plus Bluetooth® controllers use Bluetooth Low Energy (BLE) 4.0+ which complies to IEEE 802.15.1 and uses a Passkey pairing method which provides a secure connection between Bluetooth devices, including data encryption over the wireless link.

Technology Used	Bluetooth
Connection Types	SPP, iAP2, GATT
Frequency	2400 to 2483.5 MHz
Max RF Power Output	+8.2 dBm
Operating Range	33ft (10m)

## Emissions and Immunity Compliance

No.	Test/Standard	Port (Enclosure, AC, DC, I/O)	Emissions Class and Group/ Immunity Test Level
1	CISPR 11, Conducted Emissions	120 VAC/60 Hz, 230 VAC/50 Hz	Class B; Group 1
2	CISPR 11, Radiated Emissions	Enclosure	Class B; Group 1
3	IEC 61000-3-2	AC Port 230 VAC/50 Hz	Class A
4	IEC 61000-3-3	AC Port 230 VAC/50 Hz	All parameters
5	IEC 61000-4-2	Enclosure	±8kV contact ±2kV, ±4kV, ±8kV, ±15kV air
6	IEC 61000-4-3 Radiated RF Immunity	Enclosure	10V/m, 80–2700MHz, 80% 1kHz AM
7	IEC 61000-4-3 Proximity Fields from RF Wireless equipment	Enclosure	Section 8.10 of the IEC 60601-1-2 standard
8	IEC 61000-4-4	AC 120 VAC/60 Hz	2kV, 100kHz repetition rate
9	IEC 61000-4-4	I/O	1kV, 100kHz repetition rate
10	IEC 61000-4-5	AC 120 VAC/60 Hz	±0.5kV, ±1kV line-to-line ±0.5kV, ±1kV, ±2kV line-to-ground
11	IEC 61000-4-6	AC 120 VAC/60 Hz	3V, 0.15-80MHz, 80% 1kHz AM 6V in ISM band within 0.15-80MHz, 80% 1kHz AM 6V in amateur radio band within 0.15-80MHz, 80% 1kHz AM
12	IEC 61000-4-6	I/O	3V, 0.15-80MHz, 80% 1kHz AM 6V in ISM band within 0.15-80MHz, 80% 1kHz AM 6V in amateur radio band within 0.15-80MHz, 80% 1kHz AM
13	IEC 61000-4-8	Enclosure	30A/m, 50 or 60Hz
14	IEC 61000-4-11 Voltage Dips	120 VAC/60 Hz, 230 VAC/50 Hz	0% (100% reduction), 0.5 cycle 0% (100% reduction), 1 cycle 70% (30% reduction) UT, 0.5 sec

No.	Test / Standard	Port (enclosure, AC, DC, I/O)	Emissions Class and Group/ immunity test level
15	IEC 61000-4-11 Voltage Interruptions	120 VAC/60 Hz, 230 VAC/50 Hz	0% (100% reduction), 5 sec
16	IEC 61000-4-39	Enclosure	Section 8.11, Table 11 of the IEC 60601-1-2 standard

## FCC Compliance

This device contains FCC ID: QOQ-GM220P. This device complies with Part 15 of the FCC Rules. Operation is subject to the following two conditions: (1) this device may not cause harmful interference, and (2) this device must accept any interference received, including interference that may cause undesired operation. This equipment has been tested and found to comply with the limits for a Class B digital device, pursuant to part 15 of the FCC Rules. These limits are designed to provide reasonable protection against harmful interference in a residential installation. This equipment generates, uses, and can radiate radio frequency energy, and if not installed and used in accordance with the instructions, may cause harmful interference to radio communications. However, there is no guarantee that interference will not occur in a particular installation. If this equipment does cause harmful interference to radio or television reception, which can be determined by turning the equipment off and on, the user is encouraged to try to correct the interference by one or more of the following measures:

- Reorient or relocate the receiving antenna
- Increase the separation between the equipment and receiver
- Connect the equipment into an outlet on a circuit different from that to which the receiver is connected

## Bluetooth Trademark

The Bluetooth word, mark and logos are registered trademarks owned by Bluetooth SIG, Inc. and any use of such trademarks by Tactile Medical is under license.

## 10.8 Device Label

The device label is found on the back of your device. To read the label, place the device facing away from you at eye level at a distance that maximizes character clarity, generally 20 inches (50 cm) to 40 inches (100 cm) with an illumination of 500 lx minimum.

If label reading issues remain, please contact Tactile Medical's Customer Care Team.:


- **Text or Call:** 612.355.5100
- **Toll Free Phone:** 833.3TACTILE (833.382.2845)
- **Email:** customerservice@tactilemedical.com
- **Customer Care Hours:** 7 a.m. to 7 p.m. CT, Monday–Friday

### NOTES:





- *Device label not to scale.*
- *Device label depiction (**Figure 10.8.a.**) may be different than that on your device.*
- *See pages 1 and 2 for symbol definitions.*

**Tactile MEDICAL**  
MEDICAL ELECTRICAL EQUIPMENT  
AND DEVICES

3701 Wayzata Blvd, Ste 300  
Minneapolis, MN 55416 USA  
www.tactilemedical.com  
833.382.2845 (833.3TACTILE)  
Patented

ETL CLASSIFIED  
  
Intertek  
5000585


IP21

**REF** MODEL: PD32-G3

**CAUTION: RxOnly**  
NO SERVICEABLE PARTS  
RATED: 12 VDC @ 3A MAX

PN: 500433-000-00 Rev E




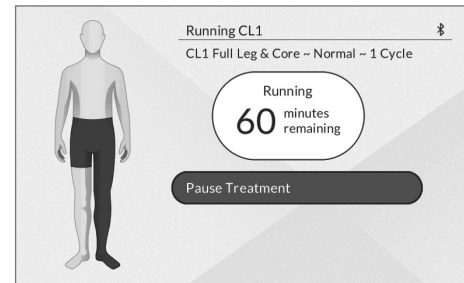
(01)00816305021400  
(21)319-123456



## Clinician-Directed Manual Pressure Adjustment

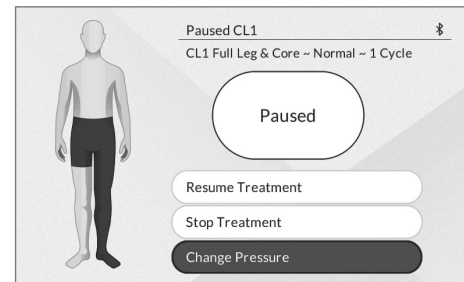
The Flexitouch Plus is designed to allow patients to manually adjust treatment pressures for individual treatment segments in different areas of the body during treatment. Follow the steps outlined below to manually adjust the pressure(s) for the individual treatment segment(s).




**NOTE:** Please consult with your healthcare provider before changing the pressure settings.

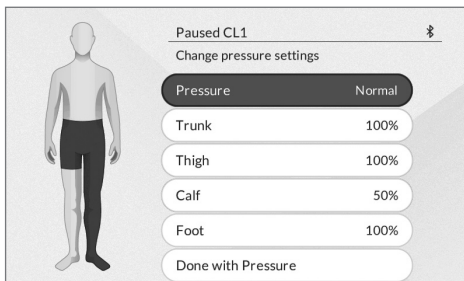
1. Press the  button on the controller unit during treatment to PAUSE TREATMENT.




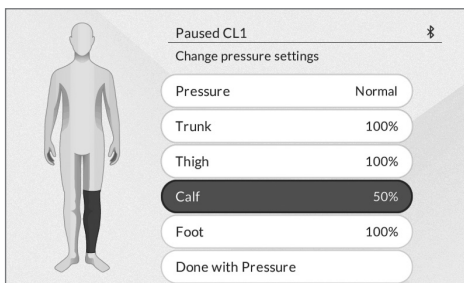
2. Press the  arrow button until the CHANGE PRESSURE option is highlighted in blue. Press the  button to select.





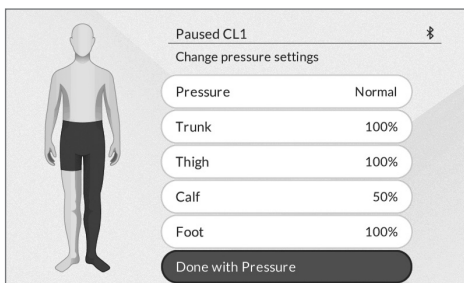
- Press the  button so the PRESSURE option is highlighted in blue to select the DECREASED, NORMAL or INCREASED options. To manually adjust treatment pressure(s) for individual segment(s) in different areas of the body, press the  and  arrow buttons to select the area of the body for which you want to change the treatment pressure.





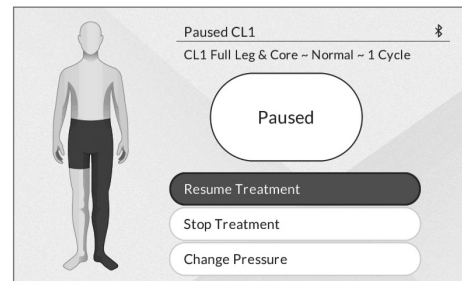
- Press the  button to manually adjust the pressure(s) for the individual treatment segment(s) when the appropriate area(s) is highlighted in blue. You can select 25, 50, 75 or 100 percent of the standard pressure for the treatment area.



- Once you have adjusted the pressure for the desired treatment area(s), use the  arrow button so the DONE WITH PRESSURE option is highlighted in blue. Press the  button to select.



- Use the  arrow button so the RESUME TREATMENT option is highlighted in blue. Press the  button to continue your treatment session. The controller unit will return with the run screen and resume treatment.



#### NOTES:

- The selected pressures will be saved for future treatment sessions. To reset the pressures to the prescribed treatment pressures, follow the steps above to set each body treatment area pressure back to 100 percent.
- Please contact Customer Care, if you or your clinician have questions about making individual pressure adjustments for your specific clinical needs.
  - Text or Call:** 612.355.5100
  - Toll Free Phone:** 833.3TACTILE (833.382.2845)
  - Email:** [customerservice@tactilemedical.com](mailto:customerservice@tactilemedical.com)
  - Customer Care Hours:** 7 a.m. to 7 p.m. CT, Monday–Friday

## For Additional Questions

If you have any questions that are not covered by this User Guide, our team is here to help. Please contact our Customer Care Team using one of the following options:

- **Text or Call:** 612.355.5100
- **Toll Free Phone:** 833.3TACTILE (833.382.2845)
- **Email:** [customerservice@tactilemedical.com](mailto:customerservice@tactilemedical.com)
- **Fax:** Toll free: 866.435.3949
- **Mail:** Tactile Medical, 3701 Wayzata Blvd, Suite 300, Minneapolis, MN 55416 USA
- **Customer Care Hours:** 7 a.m. to 7 p.m. CT, Monday–Friday

**Tactile Medical**

3701 Wayzata Blvd, Suite 300  
Minneapolis, MN 55416 USA

[tactilemedical.com](http://tactilemedical.com)

**Customer Care**

**Text or Call: 612.355.5100**

Toll Free Phone: 833.3TACTILE (833.382.2845)

Fax: 612.355.5101 / Toll Free Fax: 866.435.3949

Email: [customerservice@tactilemedical.com](mailto:customerservice@tactilemedical.com)

Hours: 7 a.m. to 7 p.m. CT, Monday–Friday

**Tactile**  
**MEDICAL®**  
HEALING RIGHT AT HOME

Tactile Medical and Flexitouch are registered trademarks, and Healing Right at Home is a trademark of Tactile Medical. DisCide® is a registered trademark of Palmero Health Care Corporation. VELCRO® is a registered trademark of Velcro IP Holdings LLC. Used with permission. No part of the contents of this User Guide may be reproduced or transmitted in any way, form or by any means without the written permission of Tactile Medical.